

BPHE

BRAZED PLATE
HEAT EXCHANGERS



BRAZED PLATE HEAT EXCHANGERS

Brazed plate heat exchangers are the perfect solution that allows to maintain high thermal performance at low operating costs.

Wide range of types, sizes, and numbers of plates and connections allows for optimizing the selection to particular application.

Copper or stainless brazing and the double wall option offer additional application possibilities. Brazed plate heat exchangers guarantee reliable, long-term operation.



WHY CHOOSE **HEXONIC** BRAZED PLATE HEAT EXCHANGERS?



HIGH PERFORMANCE

Heat exchangers are designed for very efficient operations within a wide range of applications. They guarantee compact and flexible solutions.



RELIABILITY

Advanced technology and high quality materials offer durability and reliability.



WIDE RANGE OF APPLICATIONS

Heat exchangers are used in central heating and domestic hot water systems, ventilation, technological and air-conditioning installations, as well as in heat pumps and ice water generators.



FLEXIBLE DESIGN

We offer 1- or 2-pass versions with a choice of different types of connections such as: dual (external thread / soldering), internal thread, Victaulic, stainless steel flange, carbon steel flange.



CERTIFICATES AND STANDARDS

Manufactured in accordance with ASME, UL, PED, EAC.



EASY SELECTION

User-friendly CAIRO Selection Software makes the selection process easy.

L

BRAZED PLATE HEAT EXCHANGERS

DEDICATED TO HEATING OR COOLING SYSTEMS.

APPLICATION



DOMESTIC HOT WATER SYSTEMS



CENTRAL HEATING SYSTEMS



SOLAR AND GEOTHERMIC HEATING SYSTEMS



INSTALLATIONS WITH HEAT PUMP



INSTALLATIONS WITH FIREPLACE WITH WATER JACKET

ADVANTAGES



HIGH HEAT TRANSFER COEFFICIENT



EASY ASSEMBLY AND DISMANTLE



COMPACT SIZE



RESISTANCE TO HIGH TEMPERATURE AND PRESSURE



ASYMMETRIC OPTION AVAILABLE





MICROCHANNEL BRAZED
PLATE HEAT EXCHANGER

8%
↑

**INCREASE OF HEAT EXCHANGE
EFFICIENCY BY UP TO 8%**
COMPARING TO OTHER COMPETITIVE
MICROCHANNEL HEAT EXCHANGERS

9%
↓

**REDUCTION OF FLOW
RESISTANCE BY UP TO 9%**
COMPARING TO THE MOST
EFFICIENT MICROCHANNEL HEAT
EXCHANGER ON THE MARKET

35%
↑

**INCREASE OF HEAT EXCHANGE
EFFICIENCY BY 35%**
COMPARING TO EXCHANGERS
WITH STANDARD HEAT PLATES



**HIGHER FLOW TURBULENCE
ENHANCES HEAT EXCHANGE**
THANKS TO OPTIMIZATION
OF FLOW VELOCITY

EXEMPLAR DESIGNATION

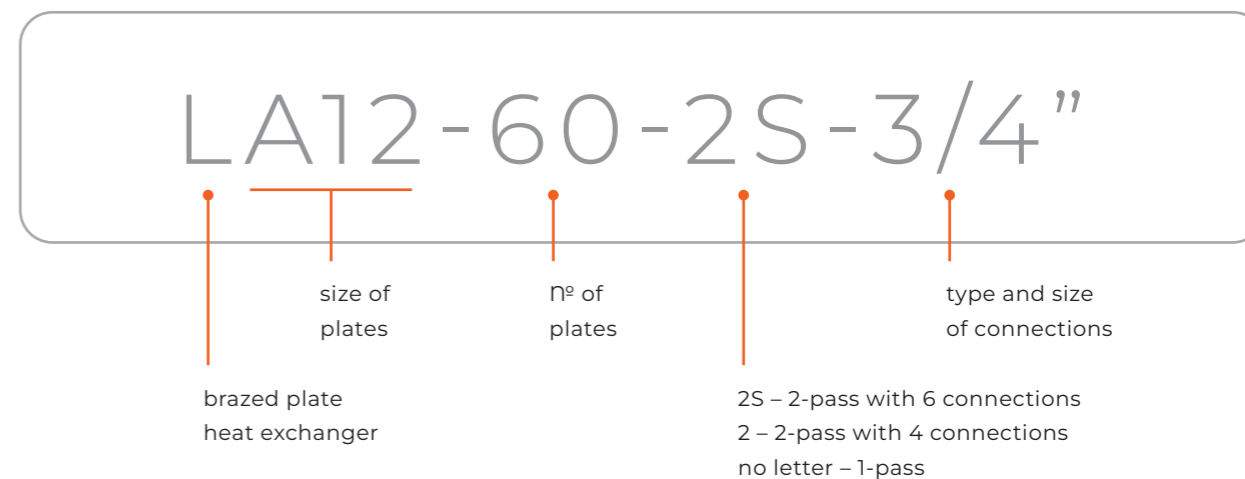

PRODUCT LINE

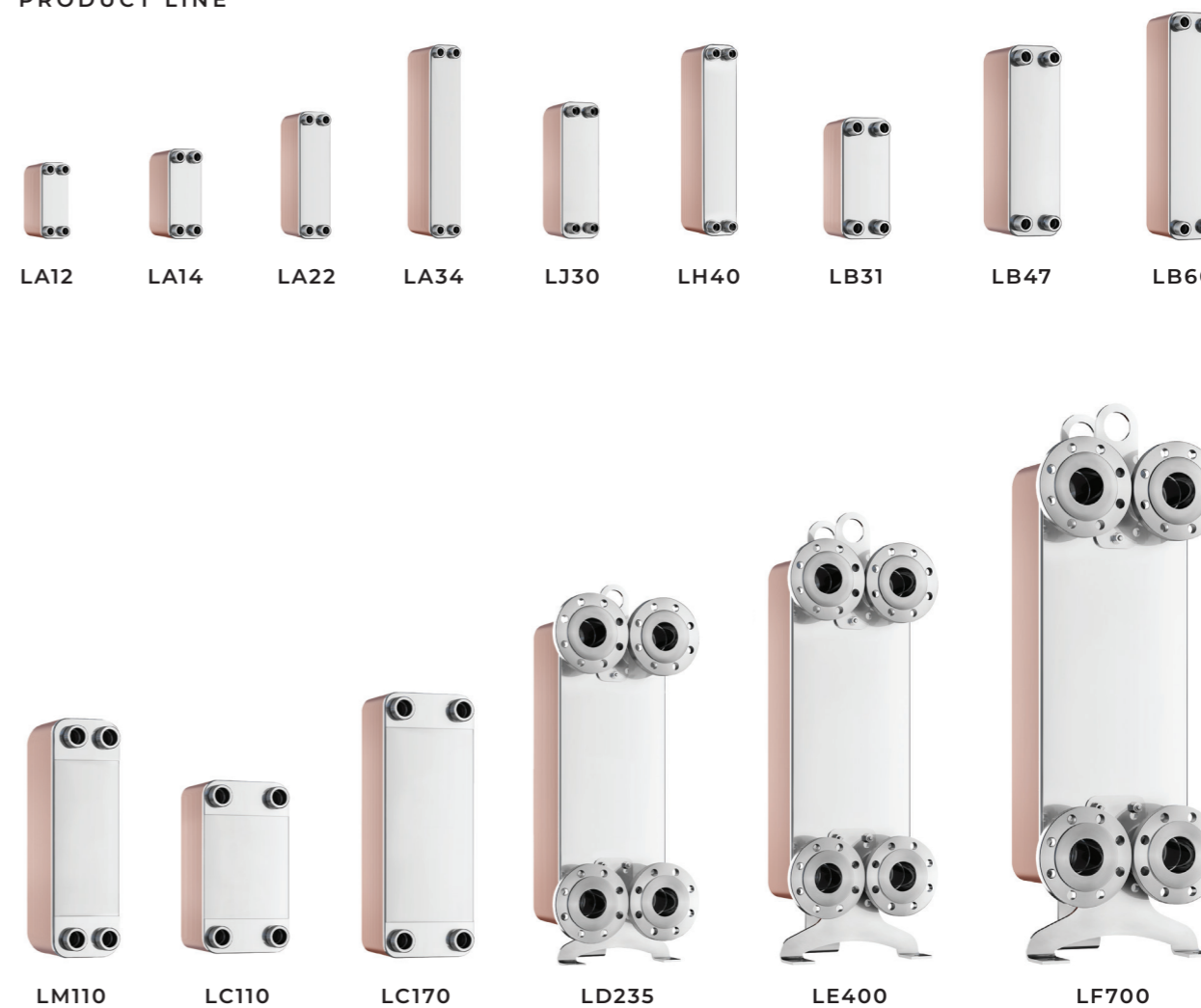

TECHNICAL DATA

STANDARD LOCATION OF CONNECTIONS

1-PASS HEAT EXCHANGER

- K1 / K4** — inlet / outlet hot side
- K3 / K2** — inlet / outlet cold side

2-PASS HEAT EXCHANGER

- D4 / K4** — inlet / outlet hot side
- K3 / D3** — inlet / outlet cold side

2-PASS WITH 6 CONNECTIONS

ADDITIONALLY:

- K1** — vent connection / inlet of central heating return
- K2** — vent connection / inlet of domestic hot water circulation return

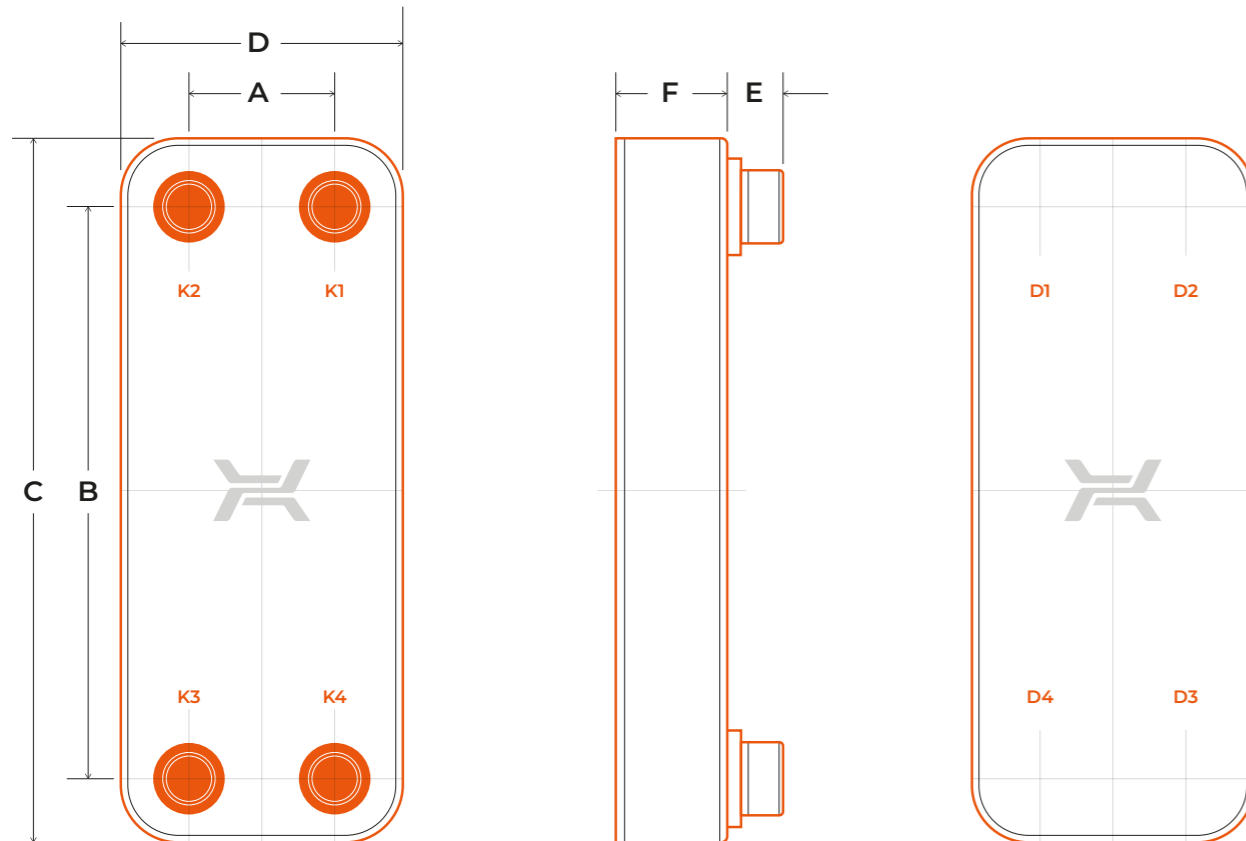

MATERIALS

- STAINLESS STEEL
- COPPER BRAZING

EXEMPLARY MEDIA

- WATER
- PROPYLENE GLYCOL SOLUTIONS
- GROUP II FLUIDS
- OTHER (CONSULT THE MANUFACTURER)

WORKING PARAMETERS

- MAX. TEMPERATURE — 230°C
- LJ — 160°C

- MIN. TEMPERATURE — -195°C
- FOR FLANGE CS — 0°C

MAX. PRESSURE

- LA, LB, LH — 3 MPA
- LM, LC, LD, LE — 2,5 MPA
- LJ, LF — 1,6 MPA

TECHNICAL PARAMETERS

Type	Dimensions												max NP	Mass	
	A		B		C		D		E		F			kg	lb
	mm	in	mm	in	mm	in	mm	in	mm	in	mm	in			
LA12	40	1.6	154	6.1	190	7.5	72	2.8	16/20	0.6/0.8	9 + 2.45 × NP	0.35 + 0.10 × NP	60	0.4 + 0.049 × NP	0.88 + 0.11 × NP
LA14	42	1.7	164	6.5	203	8.0	81	3.2	16/20	0.6/0.8	9 + 2.30 × NP	0.35 + 0.09 × NP	60	0.6 + 0.049 × NP	1.32 + 0.11 × NP
LA21AS	40	1.6	278	10.9	314	13.4	73	2.9	14	0.6	11 + 2.3 × NP	0.39 + 0.09 × NP	60	0.58 + 0.06 × NP	1.28 + 0.13 × NP
LA22	42	1.7	260	10.2	299	11.8	81	3.2	16/20	0.6/0.8	9 + 2.30 × NP	0.35 + 0.09 × NP	60	0.8 + 0.073 × NP	1.76 + 0.16 × NP
LA22(X)	42	1.7	260	10.2	299	11.8	81	3.2	16/20	0.6/0.8	9 + 1.9 × NP	0.35 + 0.07 × NP	60	0.8 + 0.073 × NP	1.76 + 0.16 × NP
LA34	42	1.7	432	17.0	471	18.5	81	3.2	16/20	0.6/0.8	9 + 2.30 × NP	0.35 + 0.09 × NP	60	1.2 + 0.116 × NP	2.65 + 0.26 × NP
LJ30	46	1.8	270	10.6	318	12.5	98	3.9	20	0.8	9 + 1.70 × NP	0.35 + 0.07 × NP	60	1.1 + 0.064 × NP	2.43 + 0.14 × NP
LH40	43	1.7	415	16.3	461	18.1	89	3.5	28	1.1	10 + 2.25 × NP	0.39 + 0.09 × NP	60	1.7 + 0.134 × NP	3.75 + 0.30 × NP
LB31	68	2.7	232	9.1	286	11.3	123	4.8	28	1.1	10 + 2.35 × NP	0.39 + 0.09 × NP	150	1.6 + 0.114 × NP	3.53 + 0.25 × NP
LB47	68	2.7	360	14.2	417	16.4	123	4.8	28	1.1	10 + 2.35 × NP	0.39 + 0.09 × NP	150	2.1 + 0.168 × NP	4.63 + 0.37 × NP
LB60	68	2.7	480	18.9	538	21.2	123	4.8	28	1.1	11 + 2.35 × NP	0.43 + 0.09 × NP	150	2.6 + 0.219 × NP	5.73 + 0.48 × NP
LB60(X)	68	2.7	480	18.9	538	21.2	123	4.8	28	1.1	11 + 1.95 × NP	0.43 + 0.077 × NP	150	2.6 + 0.219 × NP	5.73 + 0.48 × NP
LM110	91	3.6	520	20.5	619	24.4	190	7.5	48	1.9	10 + 2.60 × NP	0.39 + 0.10 × NP	200	8.4 + 0.408 × NP	18.52 + 0.90 × NP
LC110	170	6.7	378	14.9	466	18.4	258	10.2	28/38; 100	1.1/1.5; 3.9	11 + 2.40 × NP	0.43 + 0.09 × NP	200	8.7 + 0.408 × NP	19.18 + 0.90 × NP
LC110AS	170	6.7	378	14.9	466	18.4	258	10.2	28/38; 100	1.9	11 + 2.40 × NP	0.39 + 0.09 × NP	200	8.7 + 0.408 × NP	19.18 + 0.90 × NP
LC170	170	6.7	600	23.6	688	27.1	258	10.2	28/38; 100	1.1/1.5; 3.9	11 + 2.40 × NP	0.43 + 0.09 × NP	200	11.5 + 0.617 × NP	25.35 + 1.36 × NP
LD235	204	8.0	682	26.9	788	31.0	310	12.2	100	3.9	13 + 2.5 × NP	0.51 + 0.10 × NP	280	40 + 0.828 × NP	88.18 + 1.83 × NP
LE400	240	9.5	861	33.9	1008	39.7	387	15.2	93	3.7	17 + 2.75 × NP	0.67 + 0.11 × NP	400	74.3 + 1.625 × NP	163.80 + 3.58 × NP
LF700	325	12.8	1100	43.31	1327	52.24	552	21.72	115	5.51	19 + 2.3 × NP	0.75 + 0.09 × NP	400	159.2 + 3.35 × NP	406.97 + 7.39 × NP

NP – number of plates | dim. F+/-3%.

All dimensions and technical data are approximate only and may be changed without further notice.

Mass is given for 1-pass heat exchangers.

LUNA

BRAZED PLATE HEAT EXCHANGERS
ENTIRELY MADE OF STAINLESS
MATERIALS DESIGNED TO MAINTAIN
HIGH SANITARY STANDARDS.

APPLICATION

WHEN HIGH LEVEL
OF HYGIENE IS CRUCIAL



SYSTEMS WITH
DEMINERALIZED WATER



DOMESTIC HOT
WATER SYSTEMS



COOLING SYSTEMS
WITH HIGH HYGIENIC
STANDARDS

WHEN RELIABILITY
IS ESSENTIAL



CENTRAL HEATING
SYSTEMS



SYSTEMS WITH
AGGRESSIVE MEDIA



SYSTEMS WITH
GALVANIZED PIPES



INDUSTRIAL
COOLING SYSTEMS



HYDRAULIC
OIL COOLING

ADVANTAGES



STAINLESS BRAZING
ALLOWS HOMOGENEOUS
CONSTRUCTION



HIGH SANITARY
STANDARDS



RESISTANCE
TO HIGH TEMPERATURE
AND PRESSURE



RESISTANCE
TO CORROSION



HIGH
DURABILITY



WIDE RANGE
OF APPLICATIONS



NO COPPER IONS
IN THE WATER





EXEMPLAR DESIGNATION

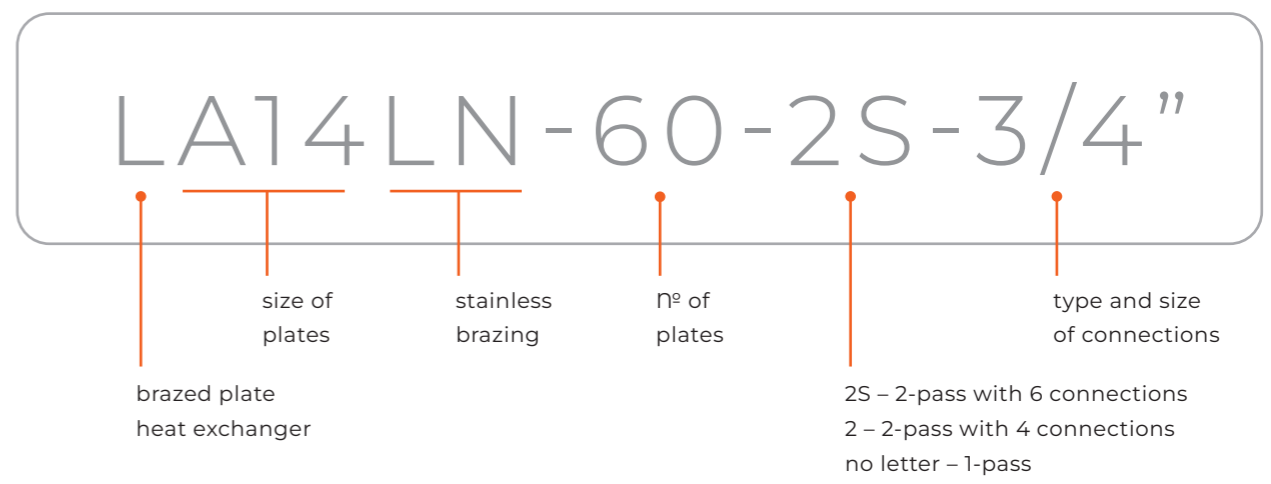

PRODUCT LINE



TECHNICAL DATA

STANDARD LOCATION OF CONNECTIONS

1-PASS HEAT EXCHANGER

- K1 / K4** — inlet / outlet hot side
- K3 / K2** — inlet / outlet cold side

2-PASS HEAT EXCHANGER

- D4 / K4** — inlet / outlet hot side
- K3 / D3** — inlet / outlet cold side

2-PASS WITH 6 CONNECTIONS

ADDITIONALLY:

- K1** — vent connection / inlet of central heating return
- K2** — vent connection / inlet of domestic hot water circulation return

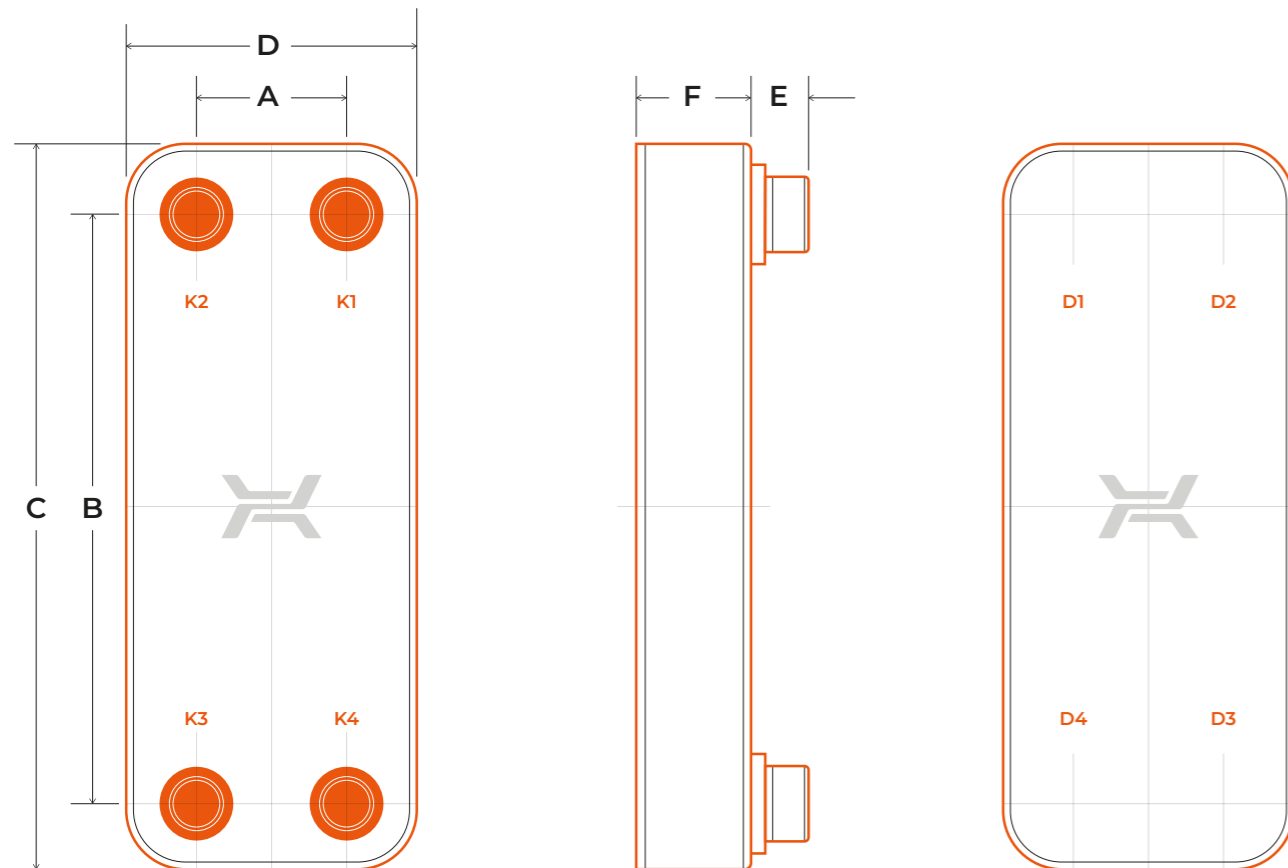

MATERIALS

- STAINLESS STEEL
- STAINLESS BRAZING

EXEMPLARY MEDIA

- WATER
- PROPYLENE
- GROUP II FLUIDS
- OTHER (CONSULT THE MANUFACTURER)

WORKING PARAMETERS

- MAX. TEMPERATURE — 200°C
- MIN. TEMPERATURE — -195°C

MAX. PRESSURE

- LA LN, LB LN — 2 MPA
- LC LN, LD LN — 1,6 MPA
- LM LN — 2,5 MPA

TECHNICAL PARAMETERS

Type	Dimensions												max n° of plates	Mass	
	A		B		C		D		E		F			kg	lb
	mm	in	mm	in	mm	in	mm	in	mm	in	mm	in			
LA14LN	42	1.7	164	6.5	203	8.0	81	3.2	16	0.6	9 + 2,3 × NP	0.35 + 0.09 × NP	60	0,6 + 0,054 × NP	1.32 + 0.12 × NP
LA22LN	42	1.7	260	10.2	299	11.8	81	3.2	16	0.6	9 + 2,3 × NP	0.35 + 0.09 × NP	60	0,8 + 0,075 × NP	1.76 + 0.17 × NP
LA34LN	42	1.7	432	17.0	471	18.5	81	3.2	16	0.6	9 + 2,3 × NP	0.35 + 0.09 × NP	60	1,2 + 0,112 × NP	2.65 + 0.25 × NP
LB31LN	68	2.7	232	9.1	286	11.3	123	4.8	28	1.1	10 + 2,35 × NP	0.39 + 0.09 × NP	150	1,6 + 0,126 × NP	3.53 + 0.28 × NP
LB47LN	68	2.7	360	14.2	417	16.4	123	4.8	28	1.1	10 + 2,35 × NP	0.39 + 0.09 × NP	150	2,2 + 0,174 × NP	4.85 + 0.38 × NP
LB60LN	68	2.7	480	18.9	538	21.2	123	4.8	28	1.1	10 + 2,35 × NP	0.39 + 0.09 × NP	150	2,7 + 0,219 × NP	5.95 + 0.48 × NP
LM110LN	91	3.6	520	20.5	619	24.4	190	7.5	48	1.9	10 + 2,6 × NP	0.39 + 0.10 × NP	180	14,68 + 0,864 × NP	6.66 + 0.392 × NP
LC110LN	170	6.7	378	14.9	466	18.4	258	10.2	28;100	1.1; 3.9	11 + 2,4 × NP	0.43 + 0.09 × NP	180	9,1 + 0,454 × NP	20.06 + 0.99 × NP
LC170LN	170	6.7	600	23.6	688	27.1	258	10.2	28;100	1.1; 3.9	11 + 2,4 × NP	0.43 + 0.09 × NP	180	11,9 + 0,642 × NP	26.24 + 1.41 × NP
LD235LN	204	8.0	682	26.9	788	31.0	310	12.2	100	3.9	13 + 2,5 × NP	0.51 + 0.1 × NP	160	40,8 + 0,049 × NP	89.95 + 0.11 × NP

NP – number of plates | dim. F+/-3%

All dimensions and technical data are approximate only and may be changed without further notice.

R

BRAZED PLATE HEAT EXCHANGERS

DESIGNED FOR USE IN COOLING OR HEATING INSTALLATIONS. REFRIGERANT EVAPORATORS, CONDENSERS AND ECONOMIZERS.

APPLICATION



CHILLERS



REFRIGERATION UNITS



HEAT PUMPS



ICE WATER GENERATORS



COOLING SYSTEMS WITH SPECIAL CONSTRUCTION

ADVANTAGES



OUTSTANDING RELIABILITY



OPTIMIZED FOR MODERN REFRIGERANTS



RESISTANCE TO CYCLIC FATIGUE



SPECIAL CHANNEL PATTERN ENSURES EFFECTIVE EVAPORATION OR CONDENSATION



RESISTANCE TO FREEZING



EVAPORATORS

A two-phase refrigerant is sent to the bottom welded connection of the exchanger. Flowing through the channels it evaporates completely while acquiring the required degree of overheating. Water or glycol flows in counter-current flow.

CONDENSERS

Hot refrigerant vapours are sent to the top welded connection of the exchanger. Flowing through the channels they condense while acquiring the required degree of subcooling. Water and glycol flows in counter-current flow.

RDS SYSTEM

Hexonic developed the unique refrigerant distribution system RDS, for evaporators with potentially higher cooling performance.

The system ensures even medium distribution in evaporator channels, while at the same time reducing steam overheating fluctuations.

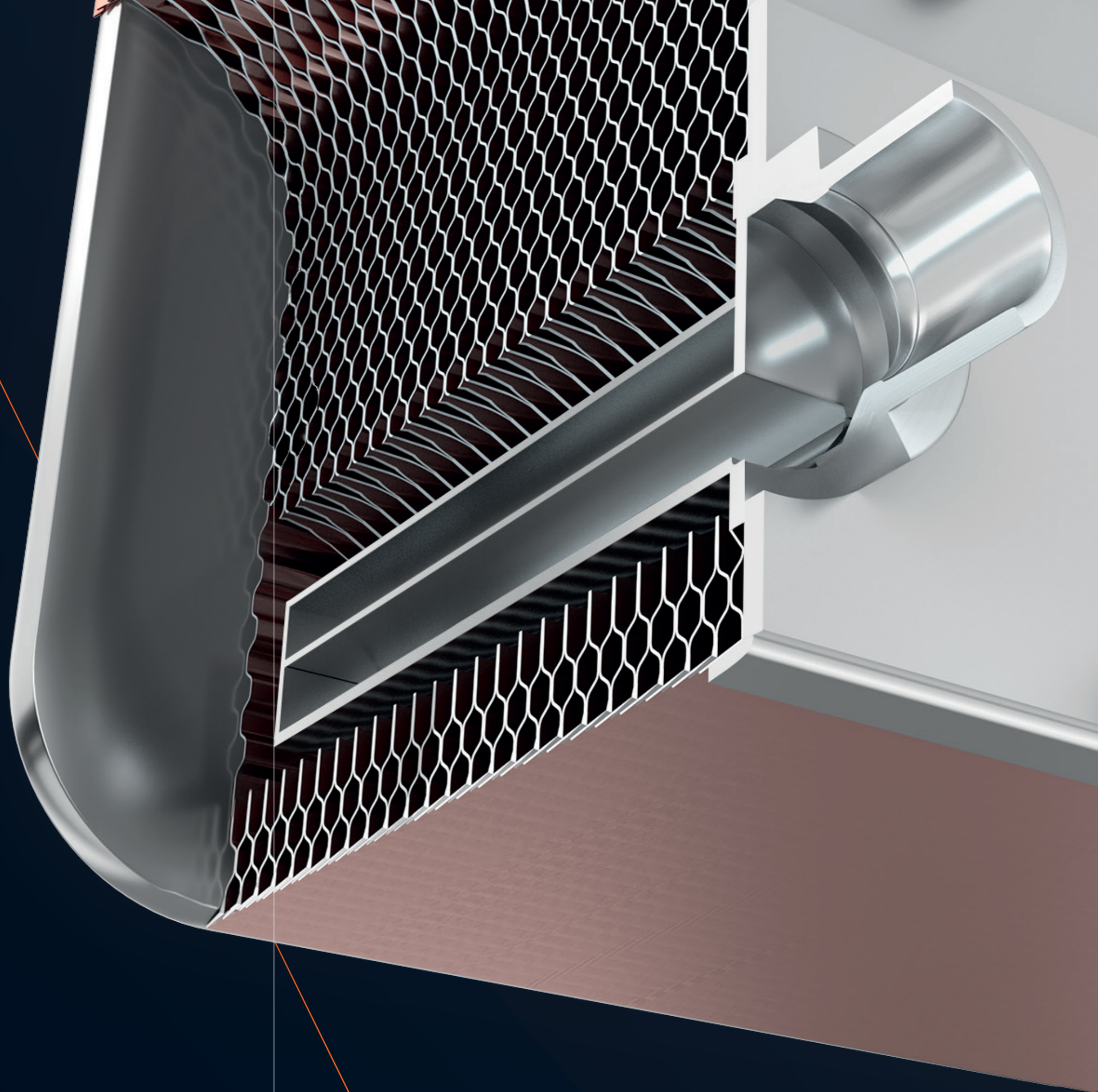



EXEMPLAR DESIGNATION

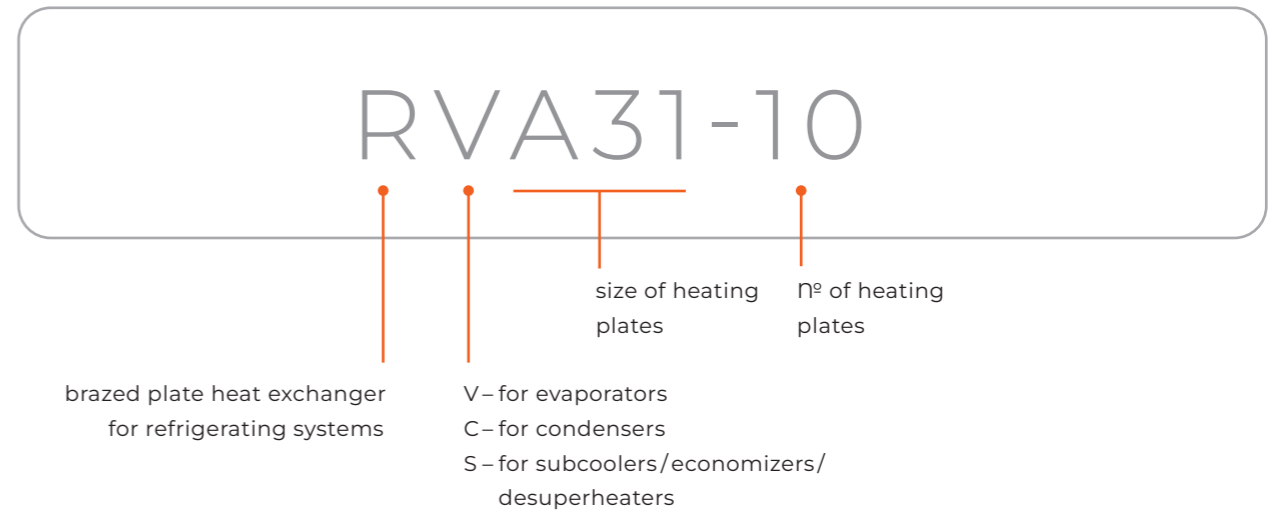

PRODUCT LINE



TECHNICAL DATA

STANDARD LOCATION OF CONNECTIONS

(DEPENDING ON WHETHER IT IS EVAPORATOR OR CONDENSER)

K 4 / K 1 — inlet /outlet of refrigerant

K 3 / K 2 — inlet /outlet of water or glycol

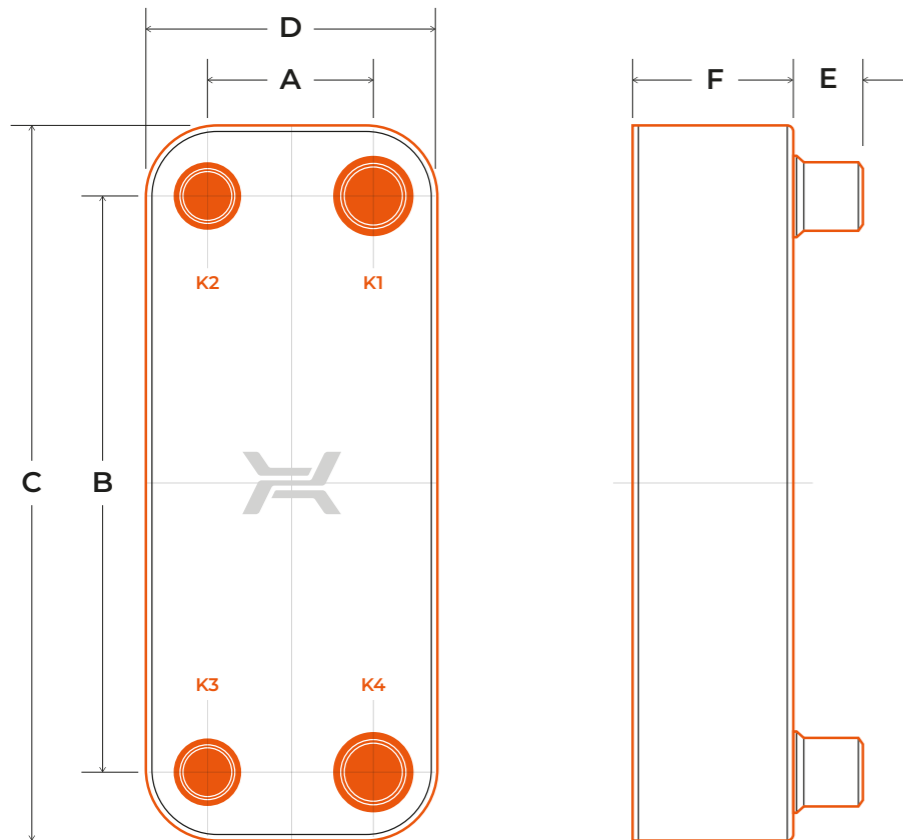

MATERIALS

- STAINLESS STEEL
- STAINLESS BRAZING
- COPPER BRAZING

EXEMPLARY MEDIA

REFRIGERANT SIDE

- R32, R452B, R454B, R1234ZE, R290, R410

OTHER SIDE

- WATER
- PROPYLENE GLYCOL SOLUTIONS
- GROUP II FLUIDS
- OTHER (CONSULT THE MANUFACTURER)

WORKING PARAMETERS

MAX. TEMPERATURE — 150°C / 302°F

MIN. TEMPERATURE — -195°C / -319°F

MAX. PRESSURE

REFRIGERANT SIDE — 4,5 MPA / 653 PSI

WATER, GLYCOL SIDE — 2,5 MPA / 363 PSI

R LUNA — 2,5 MPA / 363 PSI

TECHNICAL PARAMETERS

Type	Dimensions										Weight			
	A		B		C		D		E		F		kg	lb
	mm	in	mm	in	mm	in	mm	in	mm	in	mm	in	kg	lb

EVAPORATORS

RVA14	42	1,7	164	6,5	203	8,0	81	3,2	16	0,6	9 + 2,3 × NP	0,35 + 0,09 × NP	0,7 + 0,049 × NP	1,54 + 0,11 × NP
RVA22	42	1,7	260	10,2	299	11,8	81	3,2	16	0,6	9 + 2,3 × NP	0,35 + 0,09 × NP	0,9 + 0,073 × NP	1,98 + 0,16 × NP
RVA34	42	1,7	432	17,0	471	18,5	81	3,2	16	0,6	9 + 2,3 × NP	0,35 + 0,09 × NP	1,3 + 0,116 × NP	2,87 + 0,26 × NP
RVB31	68	2,7	232	9,1	286	11,3	123	4,8	28	1,1	10 + 2,35 × NP	0,39 + 0,09 × NP	1,7 + 0,114 × NP	3,75 + 0,25 × NP
RVB47	68	2,7	360	14,2	417	16,4	123	4,8	28	1,1	10 + 2,35 × NP	0,39 + 0,09 × NP	2,3 + 0,168 × NP	5,07 + 0,37 × NP
RVB60	68	2,7	480	18,9	538	21,2	123	4,8	28	1,1	10 + 2,35 × NP	0,39 + 0,09 × NP	2,8 + 0,219 × NP	6,17 + 0,48 × NP
RVB60X	68	2,7	480	18,9	538	21,2	123	4,8	28	1,1	13 + 1,95 × NP	0,39 + 0,077 × NP	2,8 + 0,219 × NP	6,17 + 0,48 × NP
RVC110	170	6,7	378	14,9	466	18,3	258	10,2	28	1,1	10 + 2,4 × NP	0,39 + 0,09 × NP	8,8 + 0,409 × NP	19,40 + 0,9 × NP
RVC170	170	6,7	600	23,6	688	27,1	258	10,2	28	1,1	10 + 2,4 × NP	0,39 + 0,09 × NP	11,5 + 0,617 × NP	25,35 + 1,36 × NP
RVM110	91	3,6	520	20,5	619	24,4	190	7,5	28	1,1	10 + 2,6 × NP	0,393 + 0,102 × NP	8,4 + 0,408 × NP	18,52 + 0,9 × NP
RVD235	204	8,0	682	26,9	788	31,0	310	12,2	28	1,1	13 + 2,5 × NP	0,51 + 0,10 × NP	40 + 0,828 × NP	88,18 + 1,83 × NP
RVE400	240	9,5	861	33,9	1008	39,7	387	15,2	94,3	3,7	20 + 2,75 × NP	0,79 + 0,11 × NP	81,6 + 1,625 × NP	179,90 + 3,58 × NP

CONDENSERS

RCA14	42	1,7	164	6,5	203	8,0	81	3,2	16	0,6	9 + 2,3 × NP	0,35 + 0,09 × NP	0,7 + 0,049 × NP	1,54 + 0,11 × NP
RCA22	42	1,7	260	10,2	299	11,8	81	3,2	16	0,6	9 + 2,3 × NP	0,35 + 0,09 × NP	0,9 + 0,073 × NP	1,98 + 0,16 × NP
RCA34	42	1,7	432	17,0	471	18,5	81	3,2	16	0,6	9 + 2,3 × NP	0,35 + 0,09 × NP	1,3 + 0,116 × NP	2,87 + 0,26 × NP
RCB31	68	2,7	232	9,1	286	11,3	123	4,8	28	1,1	10 + 2,35 × NP	0,35 + 0,09 × NP	1,7 + 0,114 × NP	3,75 + 0,25 × NP
RCB47	68	2,7	360	14,2	417	16,4	123	4,8	28	1,1	10 + 2,35 × NP	0,39 + 0,09 × NP	2,3 + 0,168 × NP	5,07 + 0,37 × NP
RCB60	68	2,7	480	18,9	538	21,2	123	4,8	28	1,1	10 + 2,35 × NP	0,39 + 0,09 × NP	2,8 + 0,219 × NP	6,17 + 0,48 × NP
RCB60X	68	2,7	480	18,9	538	21,2	123	4,8	28	1,1	13 + 1,95 × NP	0,39 + 0,077 × NP	2,8 + 0,219 × NP	6,17 + 0,48 × NP
RCC110	170	6,7	378	14,9	466	18,3	258	10,2	28	1,1	10 + 2,4 × NP	0,39 + 0,09 × NP	8,8 + 0,409 × NP	19,4 + 0,9 × NP
RCC170	170	6,7	600	23,6	688	27,1	258	10,2	28	1,1	10 + 2,4 × NP	0,39 + 0,09 × NP	11,5 + 0,617 × NP	25,35 + 1,36 × NP
RCM110	91	3,6	520	20,5	619	24,4	190	7,5	28	1,1	10 + 2,6 × NP	0,39 + 0,10 × NP	8,4 + 0,408 × NP	18,52 + 0,9 × NP
RCD235	204	8,0	682	26,9	788	31,0	310	12,2	28	1,1	13 + 2,5 × NP	0,51 + 0,10 × NP	40 + 0,828 × NP	88,18 + 1,83 × NP

SUBCOOLERS / ECONOMIZERS / DESUPERHEATERS

RSA14	42	1,7	164	6,5	203	8,0	81	3,2	16	0,6	9 + 2,3 × NP	0,35 + 0,09 × NP	0,7 + 0,049 × NP	1,54 + 0,11 × NP
RSA22	42	1,7	260	10,2	299	11,8	81	3,2	16	0,6	9 + 2,3 × NP	0,35 + 0,09 × NP	0,9 + 0,073 × NP	1,98 + 0,16 × NP
RSA34	42	1,7	432	17,0	471	18,5	81	3,2	16	0,6	9 + 2,3 × NP	0,35 + 0,09 × NP	1,3 + 0,116 × NP	2,87 + 0,26 × NP
RSB31	68	2,7	232	9,1	286	11,3	123	4,8	28	1,1	10 + 2,35 × NP	0,39 + 0,09 × NP	1,7 + 0,114 × NP	3,75 + 0,25 × NP
RSB47	68	2,7	360	14,2	417	16,4	123	4,8	28	1,1	10 + 2,35 × NP	0,39 + 0,09 × NP	2,3 + 0,168 × NP	5,07 + 0,37 × NP

COOLING CAPACITY TABLE FOR LOW POWER INSTALLATIONS

EVAPORATOR [dT _{GROUND SOURCE} =5K]						CONDENSER [dT _{INSTALLATION} =10K]							
W12	R32	R452B	R454B	R1234ZE	R290	R410	W35	R32	R452B	R454B	R1234ZE	R290	R410
4 kW	RVA22-60	RVA22-50	RVA22-50	RVB31H-40	RVA22-50	RVA22-50	4 kW	RCA14-40	RCA14-40	RCA14-40	RCA14-40	RCA14-50	RCA14-30
6 kW	RVA34-30	RVA34-20	RVA34-20	RVB31H-50	RVA34-20	RVA34-20	6 kW	RCA14-50	RCA14-60	RCA14-60	RCA14-60	RCA22-40	RCA14-50
9 kW	RVA34-30	RVA34-30	RVA34-30	RVC110-30	RVB31H-80	RVA34-30	9 kW	RCA22-40	RCA22-50	RCA22-50	RCA22-40	RCA22-50	RCA14-60
12 kW	RVB47H-50	RVB47H-40	RVB47H-40	RVC110-40	RVB47H-50	RVB47H-50	12 kW	RCA22-50	RCA22-60	RCA22-60	RCA22-60	RCA22-60	RCA22-50
16 kW	RVB47H-90	RVB47H-70	RVB47H-70	RVC110-50	RVC110-40	RVB47H-70	16 kW	RCA22-60	RCA34-40	RCA34-40	RCB31-80	RCA34-30	RCA22-60
20 kW	RVB60H-40	RVB60H-40	RVB60H-40	RVC110-70	RVC110-50	RVB60H-40	20 kW	RCA34-30	RCA34-40	RCA34-40	RCB31-90	RCA34-40	RCA34-50
25 kW	RVC110-80	RVC110-70	RVC110-70	RVC110-100	RVC110-70	RVC110-70	25 kW	RCA34-40	RCA34-50	RCA34-50	RCB31H-80	RCB31H-90	RCA34-60
35 kW	RVC170-40	RVC170-30	RVC170-30	RVD235-30	RVC170-30	RVC170-30	35 kW	RCA34-50	RCB47-80	RCB47-80	RC110-40	RCB47-90	RCB31H-100
50 kW	RVC170-50	RVC170-40	RVC170-40	—	RVD235-30	RVC170-50	50 kW	RCB47-90	RCB47H-100	RCB47H-100	RC110-50	RC110-60	RCB47-100
60 kW	RVC170-60	RVC170-50	RVC170-50	—	RVD235-40	RVC170-50	60 kW	RCB47H-90	RCB60-90	RCB60-90	RC110-60	RC110-70	RCB60-80
W7	R32	R452B	R454B	R1234ZE	R290	R410	W45	R32	R452B	R454B	R1234ZE	R290	R410
4 kW	RVA34-20	RVA22-50	RVA22-50	RVB31H-40	RVA22-60	RVA22-50	4 kW	RCA14-40	RCA14-50	RCA14-50	RCA14-50	RCA14-50	RCA14-50
6 kW	RVA34-30	RVA34-20	RVA34-20	RVB31H-60	RVB31H-50	RVA34-30	6 kW	RCA14-50	RCA14-60	RCA14-60	RCA22-30	RCA22-40	RCA22-40
9 kW	RVA34-40	RVB31H-90	RVB31H-90	RVC110-30	RVB31H-90	RVA34-40	9 kW	RCA22-40	RCA22-50	RCA22-50	RCA22-50	RCA22-50	RCA22-50
12 kW	RVB47H-60	RVB47H-50	RVB47H-50	RVC110-40	RVC110-30	RVB47H-50	12 kW	RCA22-50	RCA22-60	RCA22-60	RCA22-60	RCA22-60	RCA22-60
16 kW	RVB60-80	RVB47H-80	RVB47H-80	RVC110-50	RVC110-40	RVB47H-90	16 kW	RCA22-60	RCA34-40	RCA34-40	RCA34-30	RCA34-30	RCA34-40
20 kW	RVB60H-50	RVB60H-40	RVB60H-40	RVC110-70	RVC110-60	RVB60H-50	20 kW	RCA34-30	RCA34-50	RCA34-50	RCB31-100	RCA34-40	RCA34-40
25 kW	RVC110-90	RVC110-70	RVC110-80	RVD235-30	RVC110-80	RVC110-80	25 kW	RCA34-40	RCA34-60	RCA34-60	RCB31H-90	RCA34-50	RCA34-50
35 kW	RVC170-40	RVC170-30	RVC170-30	RVD235-40	RVC170-40	RVC170-40	35 kW	RCA34-50	RCB47-90	RCB47-90	RCB47-80	RCB47-90	RCB47-90
50 kW	RVC170-50	RVC170-50	RVC170-40	—	RVD235-40	RVC170-50	50 kW	RCB47-90	RCB60-80	RCB60-80	RC110-60	RCB60-80	RCB60-80
60 kW	RVC170-60	RVC170-50	RVC170-50	—	RVD235-40	RVC170-60	60 kW	RCB47H-100	RCB60-100	RCB60-100	RC110-60	RC110-70	RCB60-100
B0	R32	R452B	R454B	R1234ZE	R290	R410	W55	R32	R452B	R454B	R1234ZE	R290	R410
4 kW	RVA34-30	RVA34-30	RVA34-30	RVB47H-50	RVA34-30	RVA34-30	4 kW	RCA14-40	RCA14-40	RCA14-50	RCA14-50	RCA14-50	RCA14-50
6 kW	RVA34-40	RVA34-30	RVA34-30	RVC110-40	RVB47H-60	RVA34-40	6 kW	RCA14-60	RCA14-60	RCA22-40	RCA22-30	RCA22-40	RCA22-40
9 kW	RVB60-60	RVB60-40	RVB60-40	RVC110-50	RVB60H-40	RVB60H-40	9 kW	RCA22-40	RCA22-50	RCA22-50	RCA22-50	RCA22-50	RCA22-50
12 kW	RVB60H-50	RVB60H-40	RVB60H-40	RVC170-30	RVC110-60	RVB60H-50	12 kW	RCA22-50	RCA22-60	RCA34-30	RCA22-60	RCA34-30	RCA34-30
16 kW	RVB60H-70	RVB60H-60	RVB60H-60	RVC170-30	RVC170-30	RVC170-30	16 kW	RCA22-60	RCA34-40	RCA34-40	RCA34-30	RCA34-30	RCA34-30
20 kW	RVC170-30	RVC170-30	RVC170-30	RVD235-30	RVC170-30	RVC170-30	20 kW	RCA34-30	RCA34-50	RCA34-50	RCB31-100	RCA34-40	RCA34-40
25 kW	RVC170-40	RVC170-40	RVC170-40	RVD235-40	RVC170-40	RVC170-40	25 kW	RCA34-40	RCA34-60	RCA34-60	RCB31H-90	RCA34-50	RCA34-50
35 kW	RVC170-50	RVC170-50	RVC170-50	—	RVD235-40	RVC170-50	35 kW	RCA34-50	RCB47-90	RCB47-90	RCB47-80	RCB47-90	RCA34-60
50 kW	RVC170-70	RVC170-60	RVC170-60	—	RVD235-50	RVD235-50	50 kW	RCB47-100	RCB60-80	RCB60-90	RC110-60	RCB60-80	RCB60-80
60 kW	RVD235-60	RVD235-50	RVD235-50	—	—	RVD235-60	60 kW	RCB47H-90	RCB60-100	RCB60-100	RC110-70	RCB60-90	RCB60-90

EVAPORATOR

MEDIUM
EVAPORATION TEMP.
— 4/-1/-8°C
OVERHEATING — 3K

WATER
12/7°C – 7/2°C
DPMAX < 30KPA

PG35
0/-5°C
DPMAX < 30KPA

CONDENSER

MEDIUM
CONDENSING TEMP.
— 58/48/38°C
OVERCOOLING — 2K

WATER
23/35°C – 35/45°C – 45/55°C
DPMAX < 30KPA

ECONOMIZER

R410A	
4 kW	RSA14-10
6 kW	RSA14-10
9 kW	RSA14-20
12 kW	RSA14-30
16 kW	RSB31-15
20 kW	RSB31-20
25 kW	RSB31-20
35 kW	RSB31-30
50 kW	RSB31-40
60 kW	RSB31-60

COOLING CAPACITY TABLE FOR HIGH POWER INSTALLATIONS

EVAPORATOR [dT _{GROUND SOURCE} =10K]			CONDENSER [dT _{INSTALLATION} =5K]				
power [kW]	R1234ZE E	R134A	R290	power [kW]	R1234ZE E	R134A	R290
	W50W90 dT=10K	W45W80 dT=10K	W35W70 dT=10K		W50W90 dT=10K	W45W80 dT=10K	W35W70 dT=10K
150 kW	RVC170-60	RVC170-60	RVC170-60	150 kW	RCC110-80	RCC110-70	RCC110-50
180 kW	RVC170-70	RVC170-70	RVC170-70	180 kW	RCC110-90	RCC110-80	RCC110-60
210 kW	RVC170-80	RVC170-80	RVC170-80	210 kW	RCC110-100	RCC110-90	RCC110-70
240 kW	RVD235-70	RVD235-70	RVC170-90	240 kW	RCC170-70	RCC170-80	RCC170-80
270 kW	RVD235-80	RVD235-80	RVD235-80	270 kW	RCC170-90	RCC170-90	RCC170-90
300 kW	RVD235-90	RVD235-90	RVD235-90	300 kW	RCC170-100	RCC170-100	RCC170-100
350 kW	RVD235-100	RVD235-100	RVD235-100	350 kW	RCC170-120	RCC170-120	RCC170-120
400 kW	RVD235-120	RVD235-120	RVD235-120	400 kW	RCD235-100	RCD235-100	RCD235-100
450 kW	RVD235-130	RVD235-110	RVD235-110	450 kW	RCD235-110	RCD235-110	RCD235-110
500 kW	RVD235-140	RVD235-120	RVD235-130	500 kW	RCD235-120	RCD235-120	RCD235-120
power [kW]	R1234ZE E	R134A	R290	power [kW]	R1234ZE E	R134A	R290
	W50W90 dT=5K	W45W80 dT=5K	W35W70 dT=5K		W50W90 dT=5K	BW	W35W70 dT=5K
150 kW	RVD235-50	RVC170-70	RVC170-60	150 kW	RCC170-70	RCC170-70	RCC170-50
180 kW	RVD235-60	RVD235-50	RVD235-50	180 kW	RCC170-90	RCC170-80	RCC170-60
210 kW	RVD235-70	RVD235-60	RVD235-60	210 kW	RCC170-100	RCC170-100	RCC170-70
240 kW	RVD235-80	RVD235-70	RVD235-70	240 kW	RCC170-110	RCC170-110	RCC170-80
270 kW	RVD235-90	RVD235-80	RVD235-80	270 kW	RCC170-130	RCC170-120	RCC170-90
300 kW	—	—	RVD235-90	300 kW	RCC170-140	RCC170-130	RCC170-100
350 kW	—	—	RVD235-100	350 kW	RCD235-110	RCC170-150	RCC170-120
400 kW	—	—	RVD235-110	400 kW	RCD235-130	RCD235-120	RCD235-100
450 kW	—	—	—	450 kW	RCD235-140	RCD235-130	RCD235-110
500 kW	—	—	—	500 kW	RCD235-150	RCD235-150	RCD235-120

EVAPORATOR

MEDIUM
EVAPORATION TEMP.
— 35/30/25°C
OVERHEATING — 3K

WATER
50/45°C – 45/40°C – 35/30°C
DPMAX < 30KPA

MEDIUM
EVAPORATION TEMP.
— 45/35/30°C
OVERHEATING — 3K

WATER
50/45°C – 45/40°C – 35/30°C
DPMAX < 30KPA

CONDENSER

MEDIUM
CONDENSING TEMP.
— 100/90/80°C
OVERCOOLING — 2K

WATER
80/90°C – 70/80°C – 60/70°C
DPMAX < 30KPA

WATER
85/95°C – 75/85°C – 65/75°C
DPMAX < 30KPA

THE HIGH-PERFORMANCE PLATE

Our product range of brazed plate heat exchangers stands out for its extensive assortment and adaptable features, offering unmatched diversity in size, brazing material, connection types, flow arrangements, and accessory options. Now, we have gone one step further and created a reinforced heat exchanger dedicated to cooling and heating solutions. These ultra-efficient heat exchangers feature special heating plates "X", providing enhanced heat transfer efficiency and increased turbulence flow of the medium. Consequently, this leads to increased thermal efficiency, lower investment costs, and a reduced footprint.

EXEMPLAR DESIGNATION

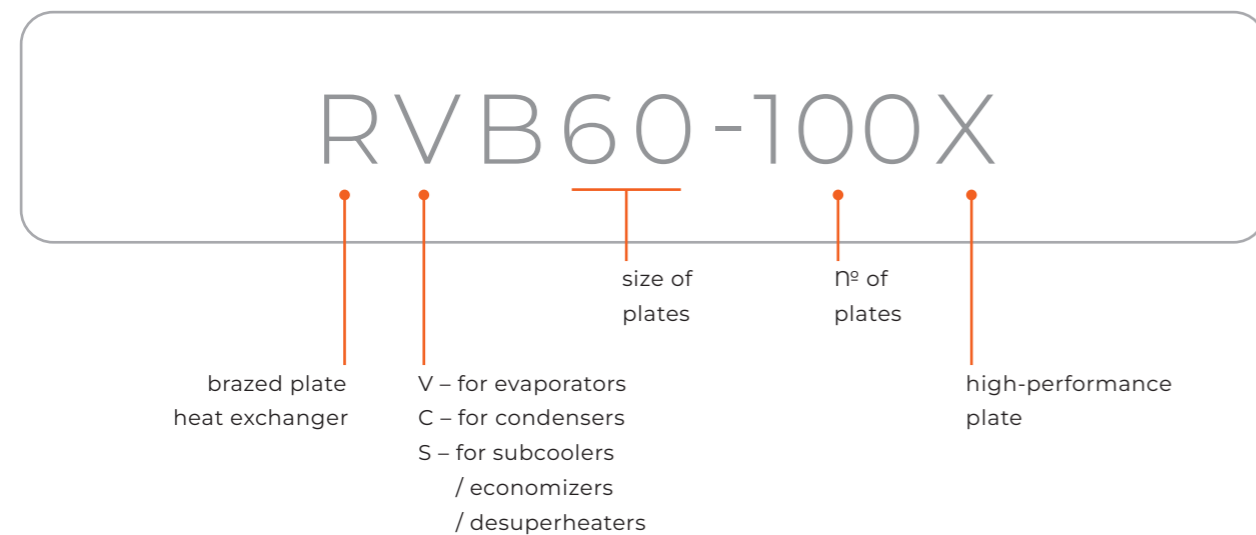
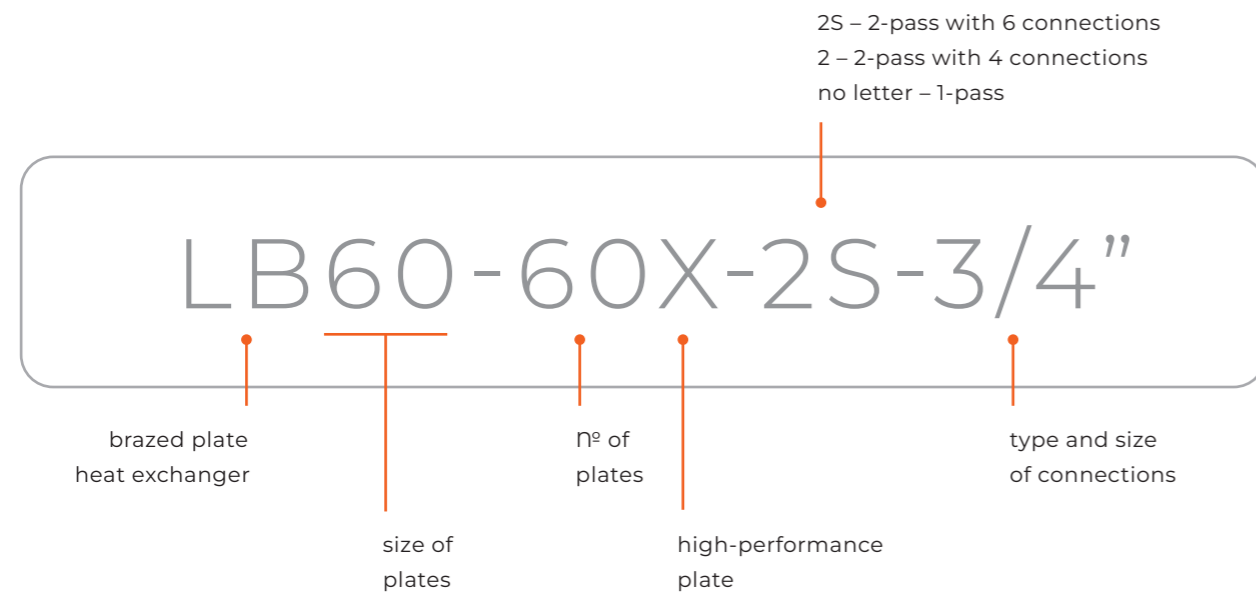

ADVANTAGES



ULTRA-EFFICIENT HEAT EXCHANGER FOR HEATING AND COOLING



INCREASED FLOW TURBULENCE OF THE MEDIUM



OPTIMIZED FLUID FLOW



REDUCED REFRIGERANT USAGE



ENHANCED THERMAL EFFICIENCY

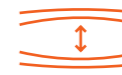

REINFORCED CONSTRUCTION FOR HIGHER PRESSURES



INCREASED HEAT EXCHANGE AREA



LOW CARBON FOOTPRINT

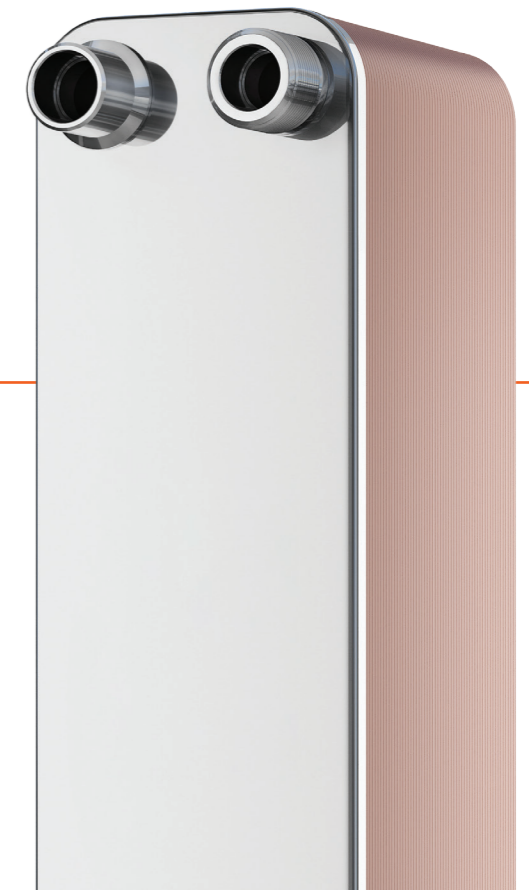

SafePLATE

DOUBLE WALL HEAT EXCHANGERS
DESIGNED FOR APPLICATIONS WHERE IT IS CRUCIAL TO DOUBLE-PROTECT MEDIA FROM MIXING AND QUICKLY DETECT ANY POTENTIAL INTERNAL LEAK.

APPLICATION



TAP WATER HEATING SYSTEMS



CENTRAL HEATING SYSTEMS



TECHNOLOGICAL SYSTEMS

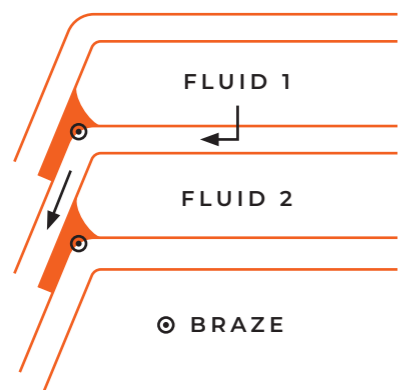

DOUBLE-WALL SYSTEM

In case of failure, either corrosion or pressure induced, special arrangement of double walls and interspace in sidewalls helps to prevent potential mixing of working media and allows the leakage to be visually detected.

ADVANTAGES



EFFECTIVE LEAK DETECTION



HELPS TO PREVENT POTENTIAL MIXING OF WORKING MEDIA

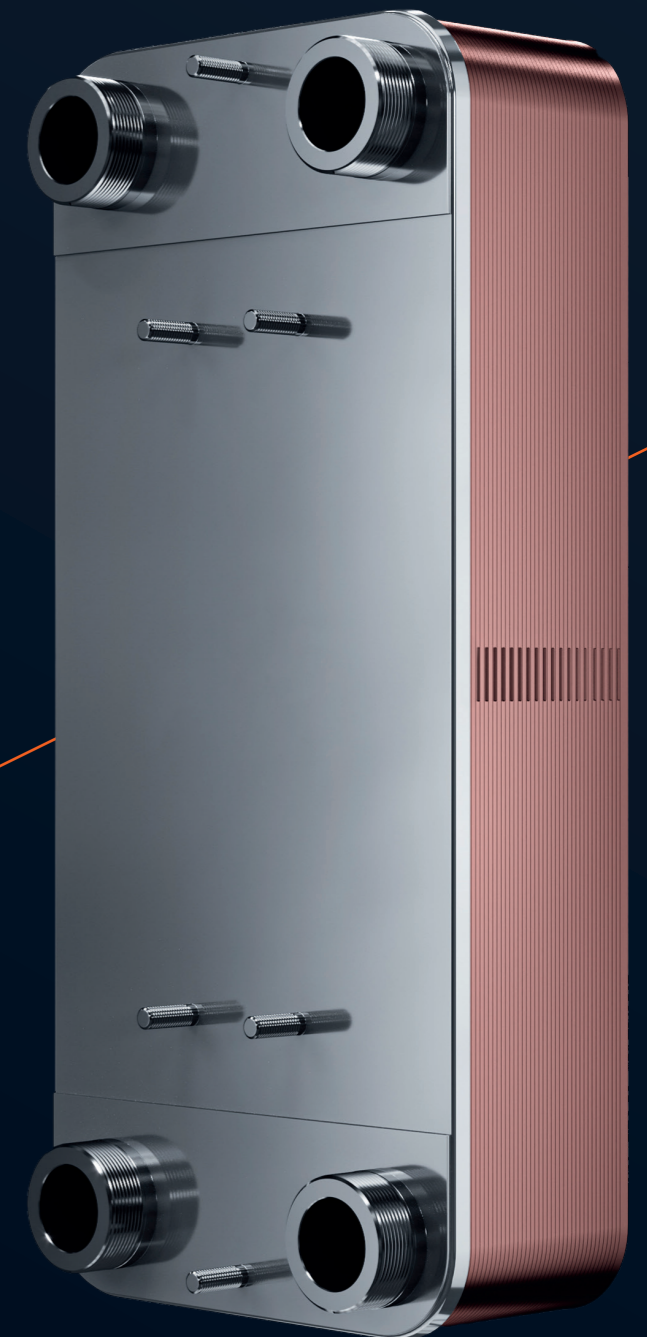

EXEMPLAR DESIGNATION

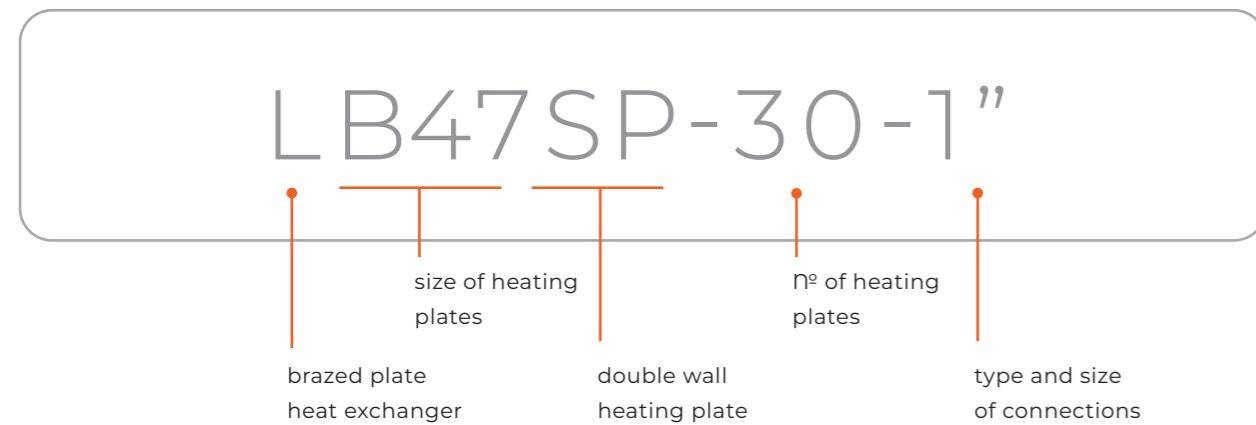

PRODUCT LINE

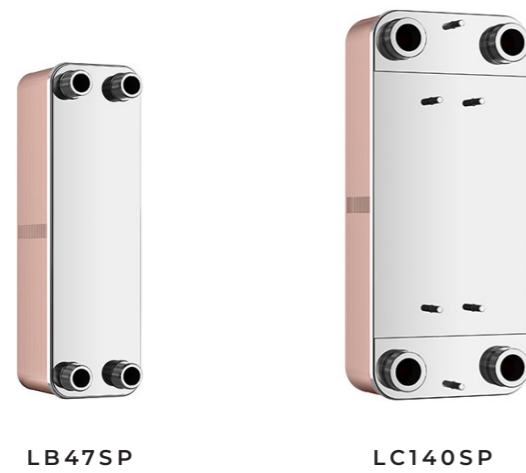

TECHNICAL DATA

MATERIALS

- STAINLESS STEEL
- COPPER BRAZING

EXEMPLARY MEDIA

- WATER
- PROPYLENE GLYCOL SOLUTIONS
- GROUP II FLUIDS
- OTHER (CONSULT THE MANUFACTURER)

WORKING PARAMETERS

MAX. TEMPERATURE — 230°C / 446°F

MIN. TEMPERATURE — -195°C / -319°F

MAX. PRESSURE — 2,5 MPA / 362 PSI

STANDARD LOCATION OF CONNECTIONS

K1 / K4 — inlet / outlet hot side **K1 / K4** — inlet / outlet hot side

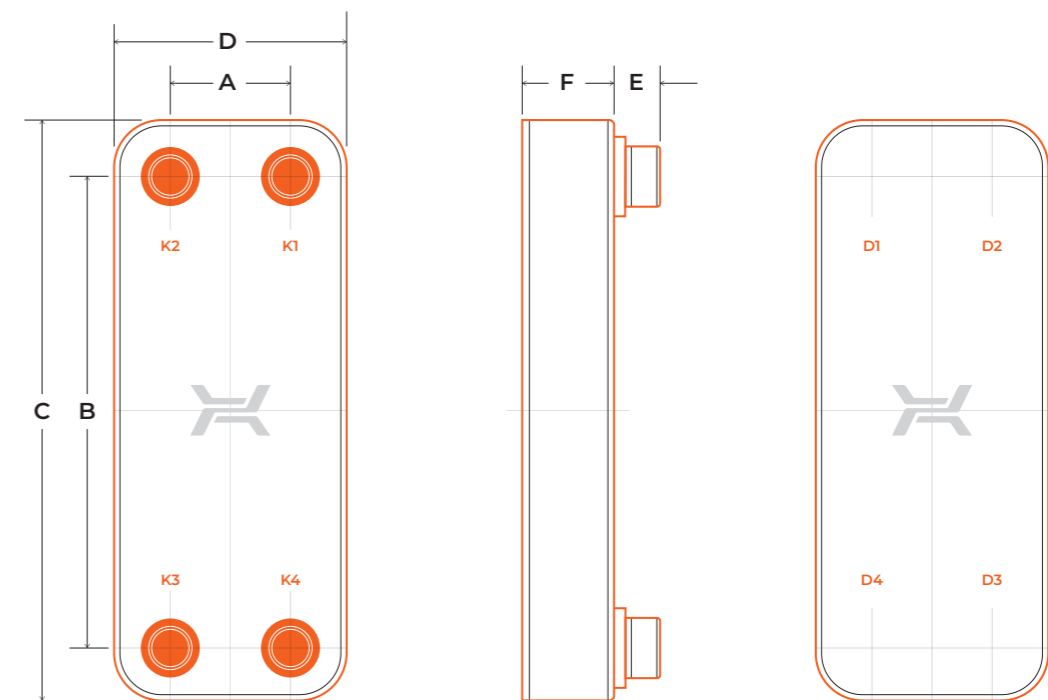

Double-wall heat exchangers have been designed to prevent media from mixing and enable quick leak detection. However, it should be remembered that no heat exchangers of this type guarantee the reliability of such operation and cannot be used instead of other safety systems.

TECHNICAL PARAMETERS

Type	Dimensions										max N° of pla- tes	Mass			
	A		B		C		D		E			F		kg	lb
	mm	in	mm	in	mm	in	mm	in	mm	in		mm	in		
LB47SP	68	2,68	360	14,17	418	16,46	126	4,93	28	1,1	11 + 2,6 × NP	0,43 + 0,10 × NP	100	3,66 + 0,26 × NP	8,07 + 0,57 × NP
LC140SP	170	6,69	490	19,29	580	22,83	260	10,23	38	1,5	11 + 2,6 × NP	0,43 + 0,10 × NP	150	9,43 + 0,822 × NP	20,08 + 1,81 × NP

NP – number of plates | dim. F +/-3%

All dimensions and technical data are approximate only and may be changed without further notice.

L ULTRA

The L ULTRA brazed plate heat exchanger combines the optimal efficiency of brazed plate heat exchangers with the resistance to high pressures. This new series features additional pressure plates in the form of a steel frame. The units can be brazed with either copper or stainless materials. Their excellent efficiency under high-pressure conditions makes them ideal for applications involving the use of CO₂.

APPLICATION



CO₂ HEAT PUMPS



CASCADE REFRIGERATION SYSTEMS



CO₂ CHILLERS



TRANSCRITICAL CO₂ SYSTEMS



POLYMER PRODUCTION



PETROCHEMICAL PROCESSES

ADVANTAGES



RESISTANT TO HIGH WORKING PRESSURES



LOW MAINTENANCE



COMPACT SIZE



GASKET-FREE DESIGN



EASY INSTALLATION



MANUFACTURED IN ACCORDANCE WITH ASME, PED, UL



LUNA™ OPTION AVAILABLE



MINIMAL SERVICE

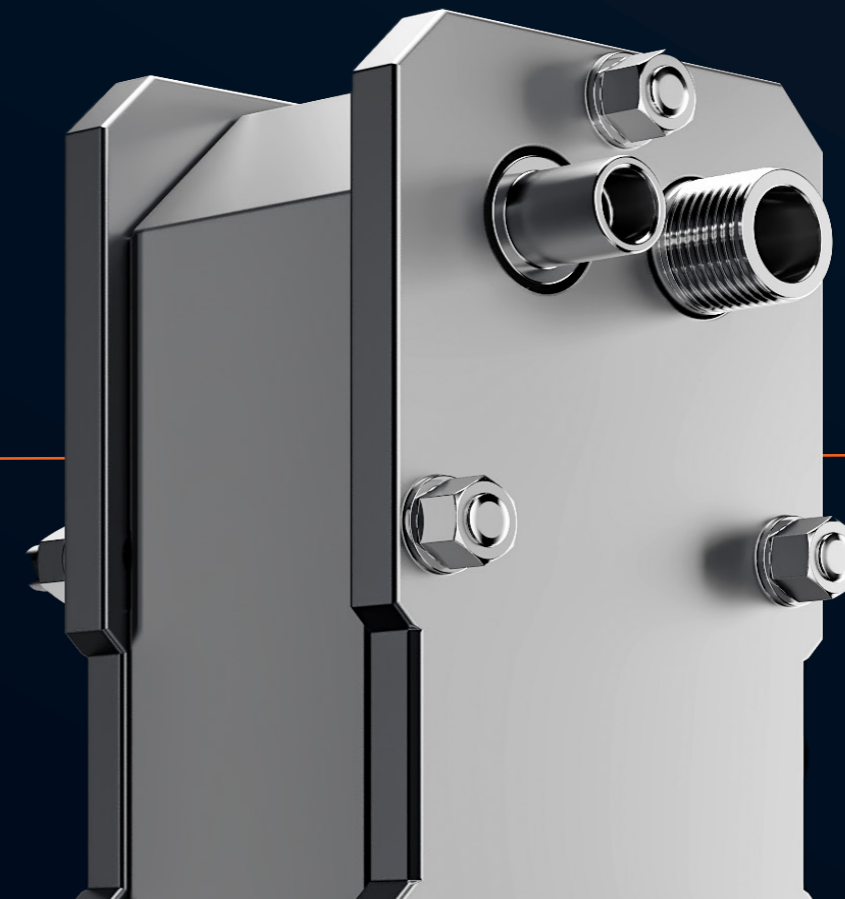

RESISTANT TO HIGH PRESSURE UP TO 140 BAR

TECHNICAL DATA

STANDARD LOCATION OF CONNECTIONS

K1 / K4 — inlet / outlet hot side
K3 / K2 — inlet / outlet cold side

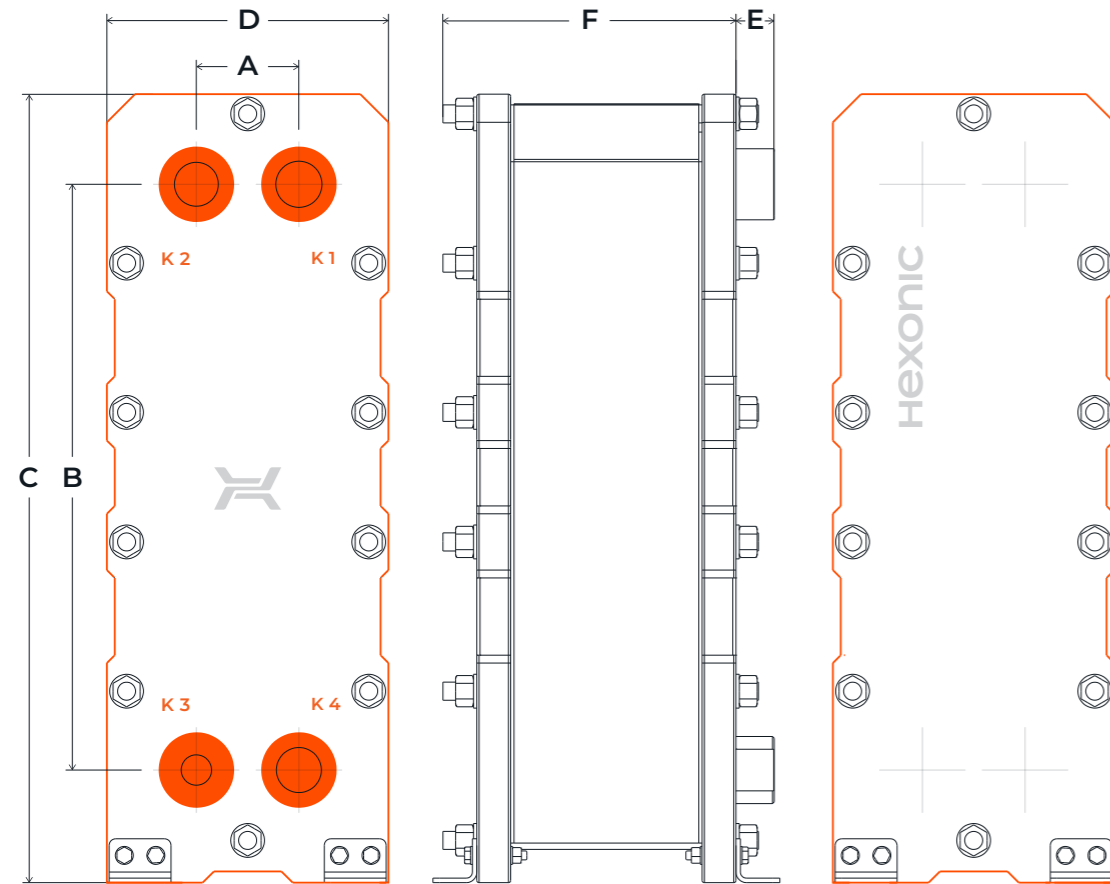

EXEMPLAR DESIGNATION

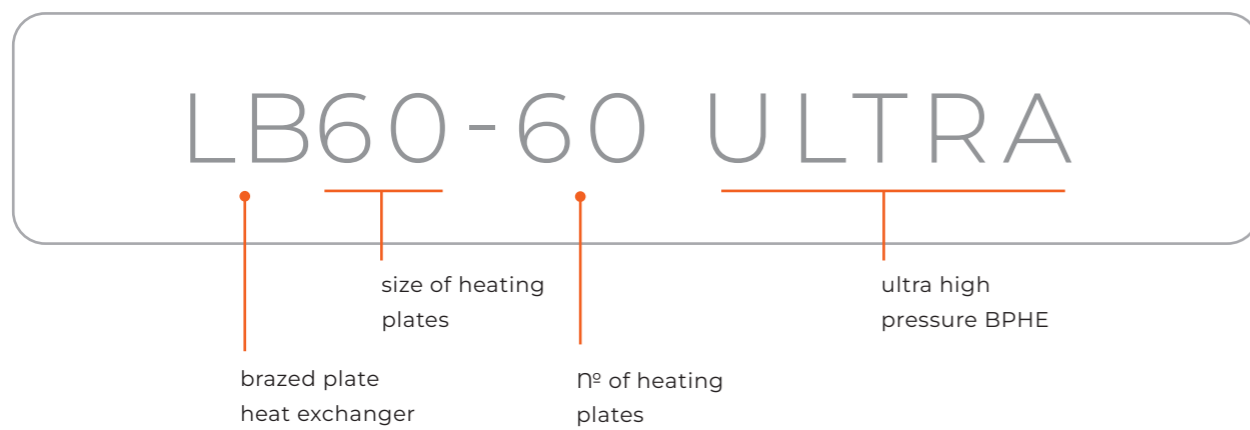

MATERIALS

- STAINLESS STEEL
- STAINLESS BRAZING
- COPPER BRAZING

WORKING PARAMETERS

MAX. TEMPERATURE — 150°C / 302°F
 MIN. TEMPERATURE — -40°C / -40°F

EXEMPLARY MEDIA

- CARBON DIOXIDE
- HYDROGEN
- INERT AND ACTIVE GASES
- HYDROCARBONS
- HYDRAULIC OILS
- PEROXIDES

MAX. PRESSURE

L ULTRA — 140 BAR / 2030 PSI
 LUNA ULTRA — 70 BAR / 1015 PSI

TECHNICAL PARAMETERS

Type	Dimensions										max N° of plates	Mass			
	A		B		C		D		E			F		kg	lb
	mm	in	mm	in	mm	in	mm	in	mm	in		mm	in		
LB60 ULTRA	68	2,68	480	18,90	620	24,41	185	7,28	36	1,42	83 + 1,95 × NP	3,27 + 0,08 × NP	150	40,6 + 0,21 × NP	89,51 + 0,46 × NP
LM110 ULTRA	91	3,58	520	20,47	700	27,56	250	9,84	34	1,34	100 + 2 × NP	3,94 + 0,08 × NP	200	93 + 0,408 × NP	205,03 + 0,90 × NP
LD235 ULTRA	204	8,03	682	26,85	920	36,22	394	15,51	100	3,94	153 + 2,2 × NP	6,02 + 0,08 × NP	280	287,2 + 0,828 × NP	633,17 + 1,83 × NP

NP – number of plates | dim. F+/-3%

All dimensions and technical data are approximate only and may be changed without further notice. Mass is given for 1-pass heat exchangers.



TYPE AND SIZE OF CONNECTIONS

L	Luna	R	Safe Plate	L ULTRA	Connections																	
					3/8"	1/2"	3/4"	1"	1 1/4"	1 1/2"	2"	2 1/2"	DN50	DN80	DN100	DN150						
LA12						⊙⊙	⊙⊙	⊙⊙														
LA14	LA14LN	RVA14	RCA14	RSA14		⊙⊙⊙	⊙⊙⊙	⊙⊙⊙														
LA22	LA22LN	RVA22	RCA22	RSA22		⊙⊙⊙	⊙⊙⊙	⊙⊙⊙														
LA34	LA34LN	RVA34	RCA34	RSA34		⊙⊙⊙	⊙⊙⊙	⊙⊙⊙														
LJ30								⊙⊙	⊙													
LH40								⊙⊙	⊙													
LB31	LB31LN	RVB31	RCB31	RSB31				⊙⊙△	⊙⊙△	⊙⊙△	△											
LB47	LB47LN	RVB47	RCB47	RSB47	LB47SP			⊙⊙△	⊙⊙△	⊙⊙△	△											
LB60	LB60LN	RVB60	RCB60		LB60 ULTRA			⊙⊙△	⊙⊙△	⊙⊙△	△											
LM110	LM110LN	RVM110	RCM110		LM100 ULTRA															⊙⊙		
LC110	LC110LN	RVC110	RCC110					⊙⊙	⊙⊙△	⊙⊙△	△	△	△	⊙⊙	⊙⊙	⊙⊙						
					LC140SP																	
LC170	LC170LN	RVC170	RCC170					⊙⊙	⊙⊙△	⊙⊙△	△	△	△	⊙⊙	⊙⊙	⊙⊙						
LD235	LD235LN	RVD235	RCD235		LD235 ULTRA																⊙⊙	
LE400																						⊙⊙
LF700																						⊙⊙

- ⊙ internal thread
- △ Victaulic
- ⊙ welded connection for R heat exchangers
- ⊙ dual (external thread and soldering)
- ⊕ flange

MOUNTING BRACKETS

MOUNTING BRACKETS ARE MANUFACTURED USING STAINLESS STEEL OR CARBON ZINC-PLATED STEEL



INSULATION

INSULATION MADE OF POLYURETHANE FOAM COVERED WITH ALUMINIUM (APFI)

- MAX. WORKING TEMPERATURE: 135°C / 275°F
- THICKNESS: 30 MM / 1.18 IN
- THERMAL CONDUCTIVITY: 0,026 W/MK / 0.015 BTU/FT. HOUR°F



INSULATION MADE OF EXPANDED POLYPROPYLENE (EPPI) WITH ALUMINIUM (APFI)

- MAX. WORKING TEMPERATURE: 110°C / 230°F
- THICKNESS: 28 MM / 1.10 IN
- THERMAL CONDUCTIVITY: 0,035 W/MK / 0.020 BTU/FT. HOUR°F



COLD INSULATION FOR R-LINE HEAT EXCHANGERS

- WORKING TEMPERATURE RANGE: -40°C TO 110°C / -40°F TO 230°F
- THICKNESS: 20 MM / 0.787 IN
- THERMAL CONDUCTIVITY: 0,037 W/MK / 0.021 BTU/FT. HOUR°F



