

BPHE

BRAZED PLATE
HEAT EXCHANGERS



BRAZED PLATE HEAT EXCHANGERS

Brazed plate heat exchangers are the perfect solution that allows to maintain high thermal performance at low operating costs.

Wide range of types, sizes, and numbers of plates and connections allows for optimizing the selection to particular application.

Copper or stainless brazing option offer additional application possibilities. Brazed plate heat exchangers guarantee reliable, long-term operation.



WHY CHOOSE **HEXONIC** BRAZED PLATE HEAT EXCHANGERS?



HIGH PERFORMANCE

Heat exchangers are designed for very efficient operations within a wide range of applications. They guarantee compact and flexible solutions.



WIDE RANGE OF APPLICATIONS

Heat exchangers are used in central heating and domestic hot water systems, ventilation, technological and air-conditioning installations, as well as in heat pumps and ice water generators.



CERTIFICATES AND STANDARDS

Manufactured in accordance with ASME, UL, PED, EAC.



RELIABILITY

Advanced technology and high quality materials offer durability and reliability.



FLEXIBLE DESIGN

We offer 1- or 2-pass versions with a choice of different types of connections such as: dual (external thread / soldering), internal thread, Victaulic, stainless steel flange, carbon steel flange.



CAIRO EASY SELECTION

User-friendly CAIRO Selection Software makes the selection process easy.

L

BRAZED PLATE HEAT EXCHANGERS

DEDICATED TO HEATING OR COOLING SYSTEMS.

APPLICATION



DOMESTIC HOT WATER SYSTEMS



CENTRAL HEATING SYSTEMS



SOLAR AND GEOTHERMIC HEATING SYSTEMS



INSTALLATIONS WITH HEAT PUMP



INSTALLATIONS WITH FIREPLACE WITH WATER JACKET

ADVANTAGES



HIGH HEAT TRANSFER COEFFICIENT



EASY ASSEMBLY AND DISMANTLE



COMPACT SIZE



RESISTANCE TO HIGH TEMPERATURE AND PRESSURE



ASYMMETRIC OPTION AVAILABLE





MICROCHANNEL BRAZED
PLATE HEAT EXCHANGER

8%
↑

**INCREASE OF HEAT EXCHANGE
EFFICIENCY BY UP TO 8%**
COMPARING TO OTHER COMPETITIVE
MICROCHANNEL HEAT EXCHANGERS

9%
↓

**REDUCTION OF FLOW
RESISTANCE BY UP TO 9%**
COMPARING TO THE MOST
EFFICIENT MICROCHANNEL HEAT
EXCHANGER ON THE MARKET

35%
↑

**INCREASE OF HEAT EXCHANGE
EFFICIENCY BY 35%**
COMPARING TO EXCHANGERS
WITH STANDARD HEAT PLATES



**HIGHER FLOW TURBULENCE
ENHANCES HEAT EXCHANGE**
THANKS TO OPTIMIZATION
OF FLOW VELOCITY

EXEMPLAR DESIGNATION

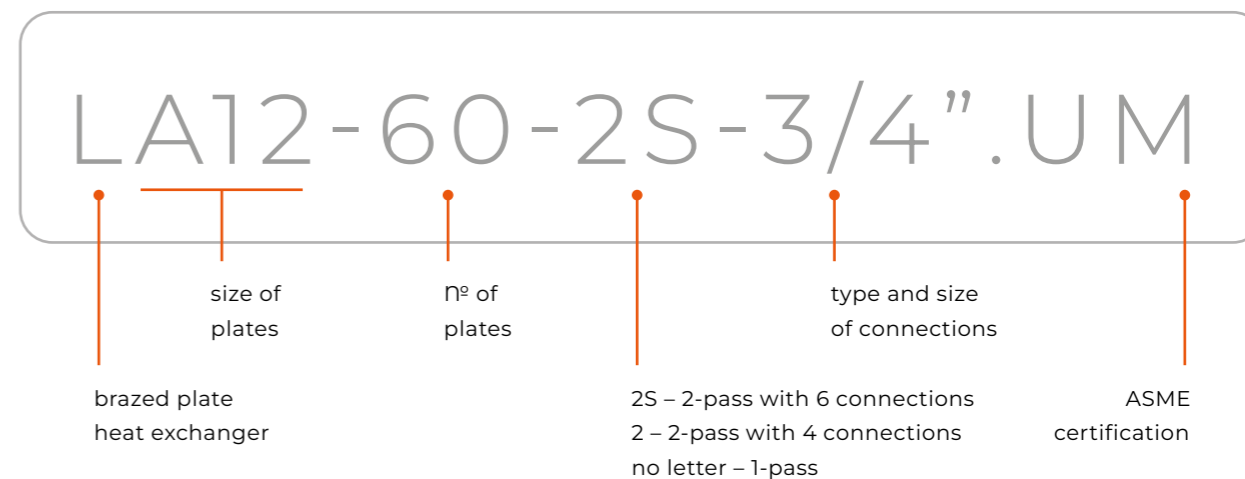

PRODUCT LINE



TECHNICAL DATA

STANDARD LOCATION OF CONNECTIONS

1-PASS HEAT EXCHANGER

- K1 / K4** — inlet / outlet hot side
K3 / K2 — inlet / outlet cold side

2-PASS HEAT EXCHANGER

- D4 / K4** — inlet / outlet hot side
K3 / D3 — inlet / outlet cold side

2-PASS WITH 6 CONNECTIONS

ADDITIONALLY:

- K1** — vent connection / inlet of central heating return
K2 — vent connection / inlet of domestic hot water circulation return

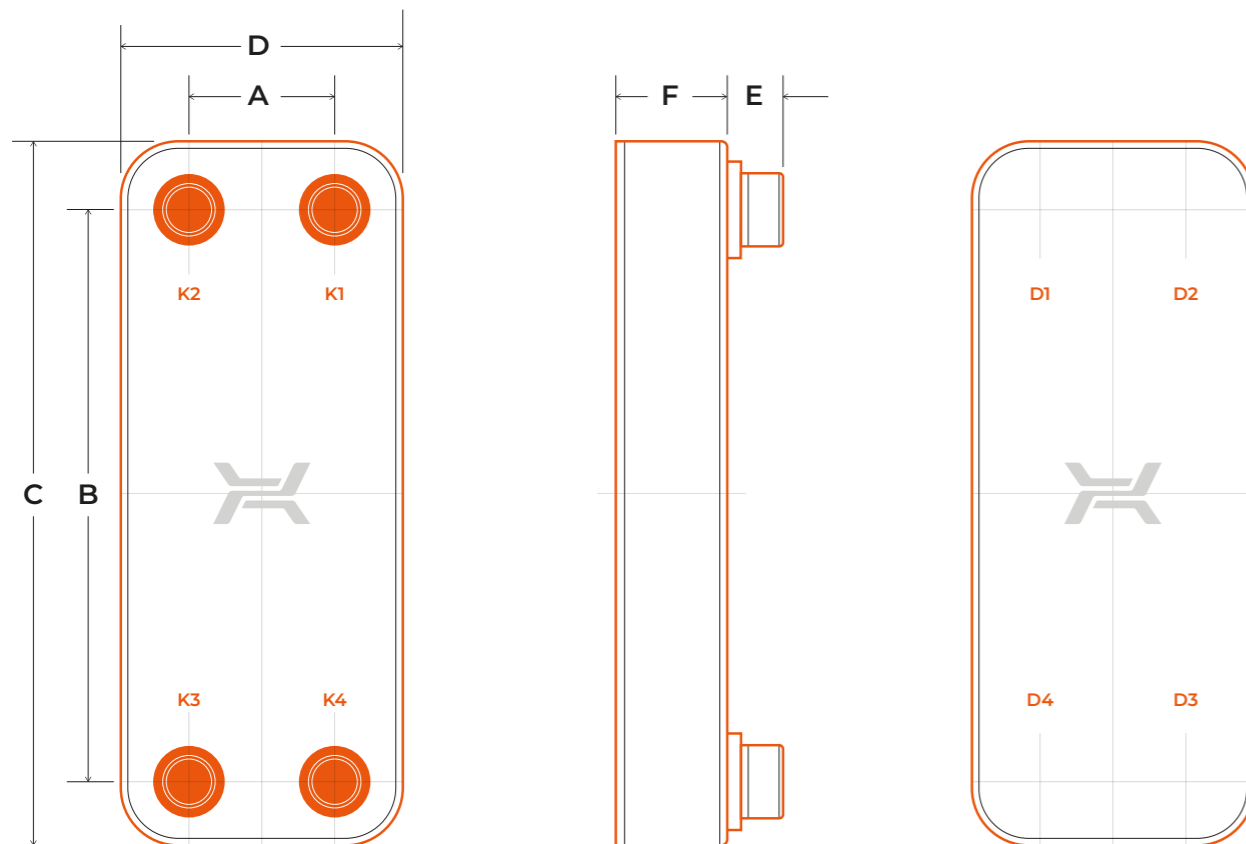

MATERIALS

- STAINLESS STEEL
 — COPPER BRAZING

EXEMPLARY MEDIA

- WATER
 — PROPYLENE GLYCOL SOLUTIONS
 — OTHER (CONSULT THE MANUFACTURER)

WORKING PARAMETERS

MAX. TEMPERATURE — 446°F

MIN. TEMPERATURE — -320°F

MAX. PRESSURE

- LA, LB, LH, LM — 435 PSI
 LC, LD, LE — 362 PSI
 LJ, LF — 232 PSI

TECHNICAL PARAMETERS

Type	Dimensions						max П°	Mass
	A	B	C	D	E	F		
	in	in	in	in	in	in	lb	
LA12	1.6	6.1	7.5	2.8	0.6/0.8	0.35 + 0.10 × NP	60	0.88 + 0.11 × NP
LA14	1.7	6.5	8.0	3.2	0.6/0.8	0.35 + 0.09 × NP	60	1.32 + 0.11 × NP
LA21AS	1.6	10.9	13.4	2.9	0.6	0.39 + 0.09 × NP	60	1.28 + 0.13 × NP
LA22	1.7	10.2	11.8	3.2	0.6/0.8	0.35 + 0.09 × NP	60	1.76 + 0.16 × NP
LA22(X)	1.7	10.2	11.8	3.2	0.6/0.8	0.35 + 0.07 × NP	60	1.76 + 0.16 × NP
LA34	1.7	17.0	18.5	3.2	0.6/0.8	0.35 + 0.09 × NP	60	2.65 + 0.26 × NP
LJ30	1.8	10.6	12.5	3.9	0.8	0.35 + 0.07 × NP	60	2.43 + 0.14 × NP
LH40	1.7	16.3	18.1	3.5	1.1	0.39 + 0.09 × NP	60	3.75 + 0.30 × NP
LB31	2.7	9.1	11.3	4.8	1.1	0.39 + 0.09 × NP	150	3.53 + 0.25 × NP
LB47	2.7	14.2	16.4	4.8	1.1	0.39 + 0.09 × NP	150	4.63 + 0.37 × NP
LB60	2.7	18.9	21.2	4.8	1.1	0.43 + 0.09 × NP	150	5.73 + 0.48 × NP
LB60(X)	2.7	18.9	21.2	4.8	1.1	0.43 + 0.08 × NP	150	5.73 + 0.48 × NP
LM110	3.6	20.5	24.4	7.5	1.9	0.39 + 0.10 × NP	200	22.13 + 0.90 × NP
LM110(X)	3.6	20.5	24.4	7.5	1.9	0.39 + 0.08 × NP	200	22.13 + 0.90 × NP
LC110	6.7	14.9	18.4	10.2	1.1/1.5; 3.9	0.43 + 0.09 × NP	200	23.46 + 0.90 × NP
LC110AS	6.7	14.9	18.4	10.2	1.9	0.39 + 0.09 × NP	200	19.18 + 0.90 × NP
LC170	6.7	23.6	27.1	10.2	1.1/1.5; 3.9	0.43 + 0.09 × NP	200	29.63 + 1.36 × NP
LD235	8.0	26.9	31.0	12.2	3.9	0.51 + 0.10 × NP	280	88.18 + 1.83 × NP
LE400	9.5	33.9	39.7	15.2	3.7	0.67 + 0.11 × NP	400	163.80 + 3.58 × NP
LF700	12.8	43.31	52.24	21.72	5.51	0.75 + 0.09 × NP	400	406.97 + 7.39 × NP

NP – number of plates | dim. F+/-3%.

All dimensions and technical data are approximate only and may be changed without further notice.

Mass is given for 1-pass heat exchangers.

LUNA

BRAZED PLATE HEAT EXCHANGERS
 ENTIRELY MADE OF STAINLESS
 MATERIALS DESIGNED TO MAINTAIN
 HIGH SANITARY STANDARDS.

APPLICATION

WHEN HIGH LEVEL
 OF HYGIENE IS CRUCIAL



SYSTEMS WITH
 DEMINERALIZED WATER



DOMESTIC HOT
 WATER SYSTEMS



COOLING SYSTEMS
 WITH HIGH HYGIENIC
 STANDARDS

WHEN RELIABILITY
 IS ESSENTIAL



CENTRAL HEATING
 SYSTEMS



SYSTEMS WITH
 AGGRESSIVE MEDIA

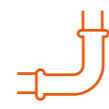

SYSTEMS WITH
 GALVANIZED PIPES



INDUSTRIAL
 COOLING SYSTEMS



HYDRAULIC
 OIL COOLING

ADVANTAGES



STAINLESS BRAZING
 ALLOWS HOMOGENEOUS
 CONSTRUCTION



HIGH SANITARY
 STANDARDS



RESISTANCE
 TO HIGH TEMPERATURE
 AND PRESSURE



RESISTANCE
 TO CORROSION



HIGH
 DURABILITY



WIDE RANGE
 OF APPLICATIONS



NO COPPER IONS
 IN THE WATER





EXEMPLAR DESIGNATION

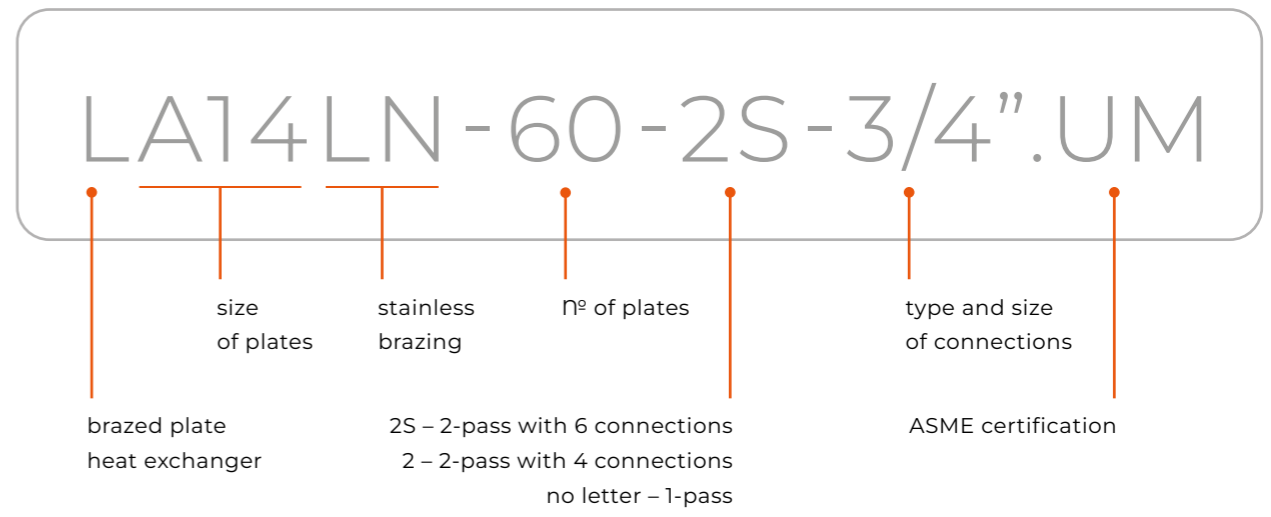

PRODUCT LINE

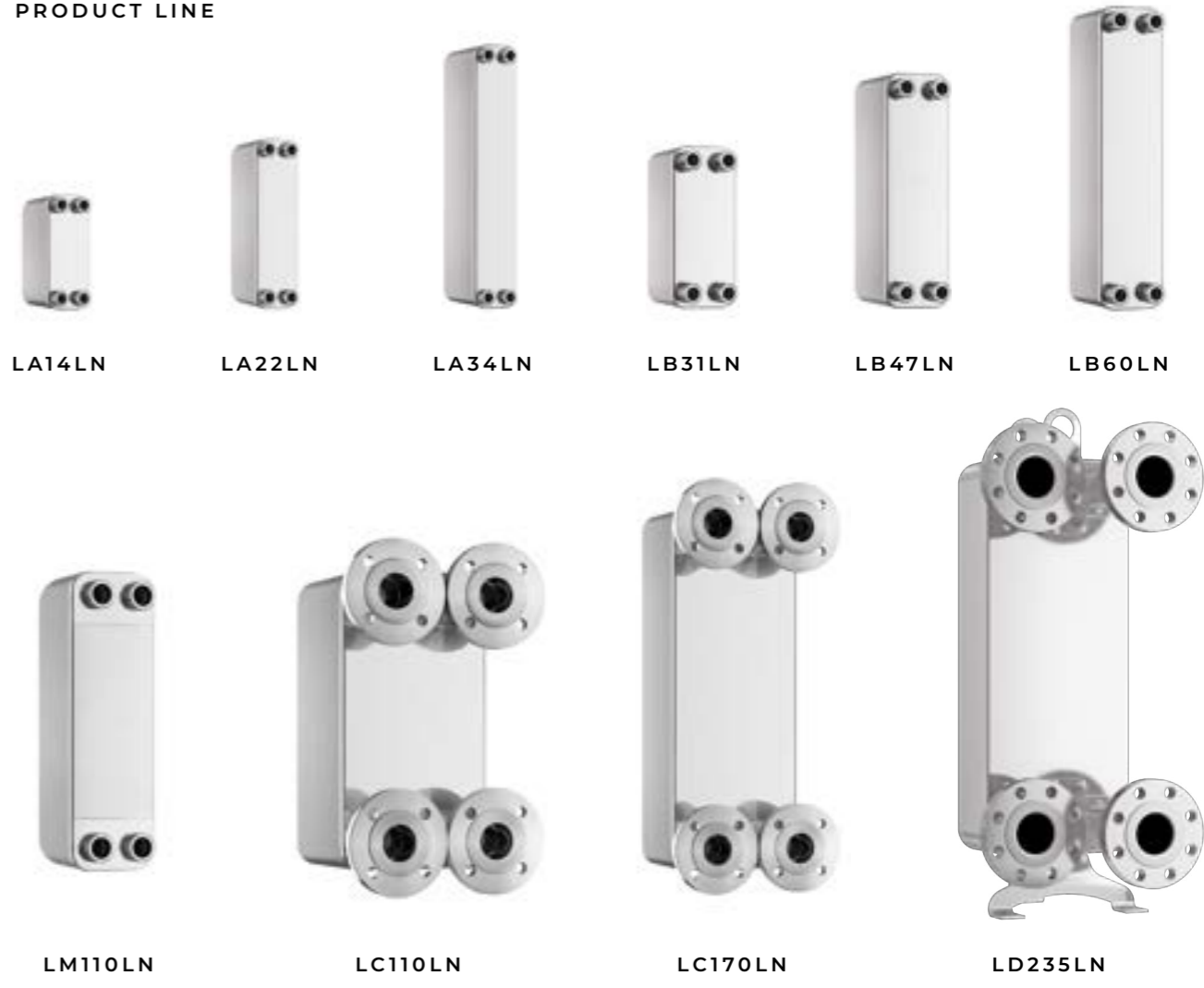

TECHNICAL DATA

STANDARD LOCATION OF CONNECTIONS

1-PASS HEAT EXCHANGER

- K1 / K4** — inlet / outlet hot side
- K3 / K2** — inlet / outlet cold side

2-PASS HEAT EXCHANGER

- D4 / K4** — inlet / outlet hot side
- K3 / D3** — inlet / outlet cold side

2-PASS WITH 6 CONNECTIONS

ADDITIONALLY:

- K1** — vent connection / inlet of central heating return
- K2** — vent connection / inlet of domestic hot water circulation return

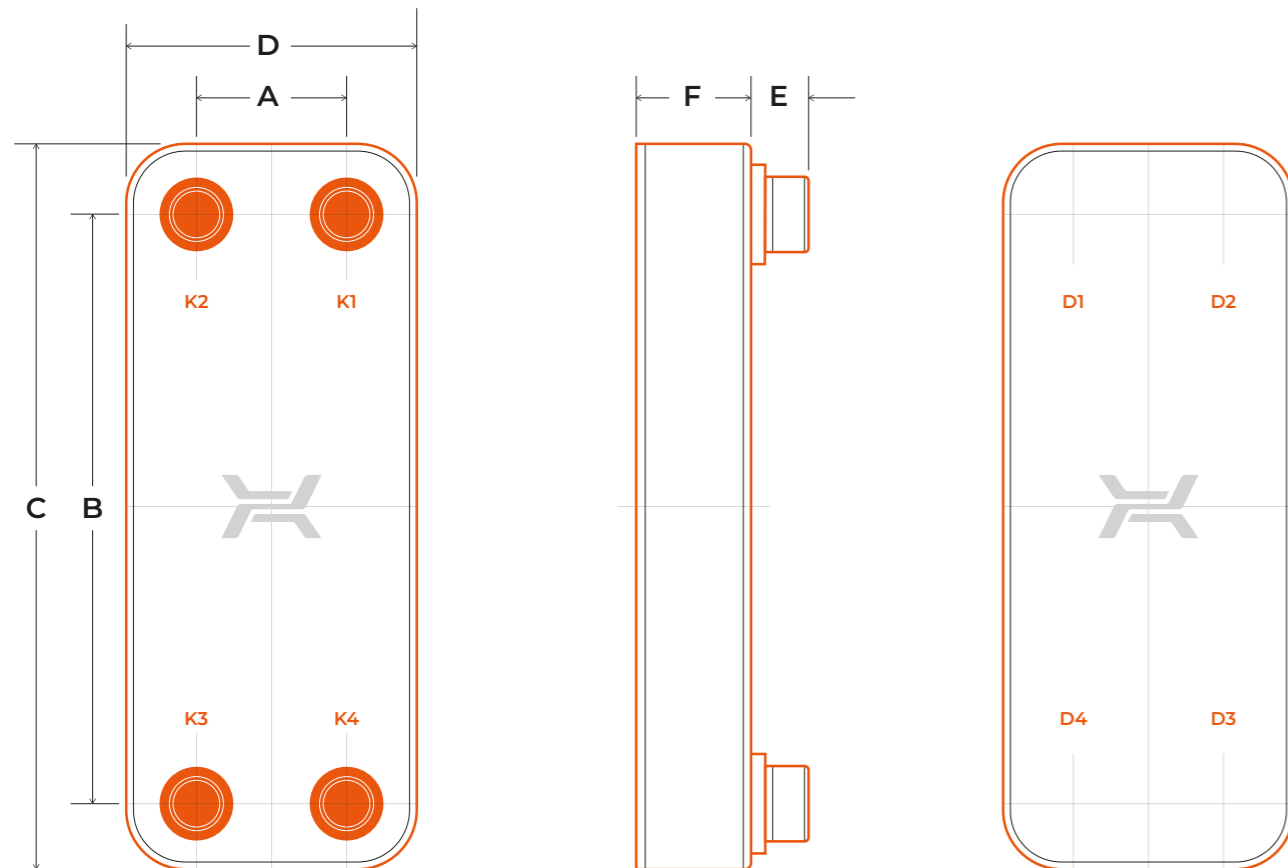

MATERIALS

- STAINLESS STEEL
- STAINLESS BRAZING

EXEMPLARY MEDIA

- WATER
- PROPYLENE GLYCOL SOLUTIONS
- OTHER (CONSULT THE MANUFACTURER)

WORKING PARAMETERS

MAX. TEMPERATURE — 392°F

MIN. TEMPERATURE — -320°F

MAX. PRESSURE

- LA LN, LB LN — 290 PSI
- LC LN, LD LN — 362 PSI
- LM LN — 400 PSI

TECHNICAL PARAMETERS

Type	Dimensions						max N° of plates	Mass
	A	B	C	D	E	F		
	in	in	in	in	in	in	lb	
LA14LN	1.7	6.5	8.0	3.2	0.6	0.35 + 0.09 × NP	60	1.32 + 0.12 × NP
LA22LN	1.7	10.2	11.8	3.2	0.6	0.35 + 0.09 × NP	60	1.76 + 0.17 × NP
LA34LN	1.7	17.0	18.5	3.2	0.6	0.35 + 0.09 × NP	60	2.65 + 0.25 × NP
LB31LN	2.7	9.1	11.3	4.8	1.1	0.39 + 0.09 × NP	150	3.53 + 0.28 × NP
LB47LN	2.7	14.2	16.4	4.8	1.1	0.39 + 0.09 × NP	150	4.85 + 0.38 × NP
LB60LN	2.7	18.9	21.2	4.8	1.1	0.39 + 0.09 × NP	150	5.95 + 0.48 × NP
LM110LN	3.6	20.5	24.4	7.5	1.9	0.39 + 0.10 × NP	200	24.03 + 0.90 × NP
LM110LN(X)	3.6	20.5	24.4	7.5	1.9	0.39 + 0.08 × NP	200	24.03 + 0.90 × NP
LC110LN	6.7	14.9	18.4	10.2	1.1; 3.9	0.43 + 0.09 × NP	200	23.46 + 0.90 × NP
LC170LN	6.7	23.6	27.1	10.2	1.1; 3.9	0.43 + 0.09 × NP	200	32.54 + 1.36 × NP
LD235LN	8.0	26.9	31.0	12.2	3.9	0.51 + 0.1 × NP	160	89.95 + 0.11 × NP

NP – number of plates | dim. F+/-3%

All dimensions and technical data are approximate only and may be changed without further notice.

R

BRAZED PLATE HEAT EXCHANGERS

DESIGNED FOR USE IN COOLING OR HEATING INSTALLATIONS. REFRIGERANT EVAPORATORS, CONDENSERS AND ECONOMIZERS.

APPLICATION



CHILLERS



REFRIGERATION UNITS



HEAT PUMPS



ICE WATER GENERATORS



COOLING SYSTEMS WITH SPECIAL CONSTRUCTION

ADVANTAGES



OUTSTANDING RELIABILITY



OPTIMIZED FOR MODERN REFRIGERANTS



RESISTANCE TO CYCLIC FATIGUE



SPECIAL CHANNEL PATTERN ENSURES EFFECTIVE EVAPORATION OR CONDENSATION



RESISTANCE TO FREEZING



DOUBLE WALL OPTION AVAILABLE



LUNA™ OPTION AVAILABLE



EVAPORATORS

A two-phase refrigerant is sent to the bottom welded connection of the exchanger. Flowing through the channels it evaporates completely while acquiring the required degree of overheating. Water or glycol flows in counter-current flow.

CONDENSERS

Hot refrigerant vapours are sent to the top welded connection of the exchanger. Flowing through the channels they condense while acquiring the required degree of subcooling. Water and glycol flows in counter-current flow.

RDS SYSTEM

Hexonic developed the unique refrigerant distribution system RDS, for evaporators with potentially higher cooling performance.

The system ensures even medium distribution in evaporator channels, while at the same time reducing steam overheating fluctuations.

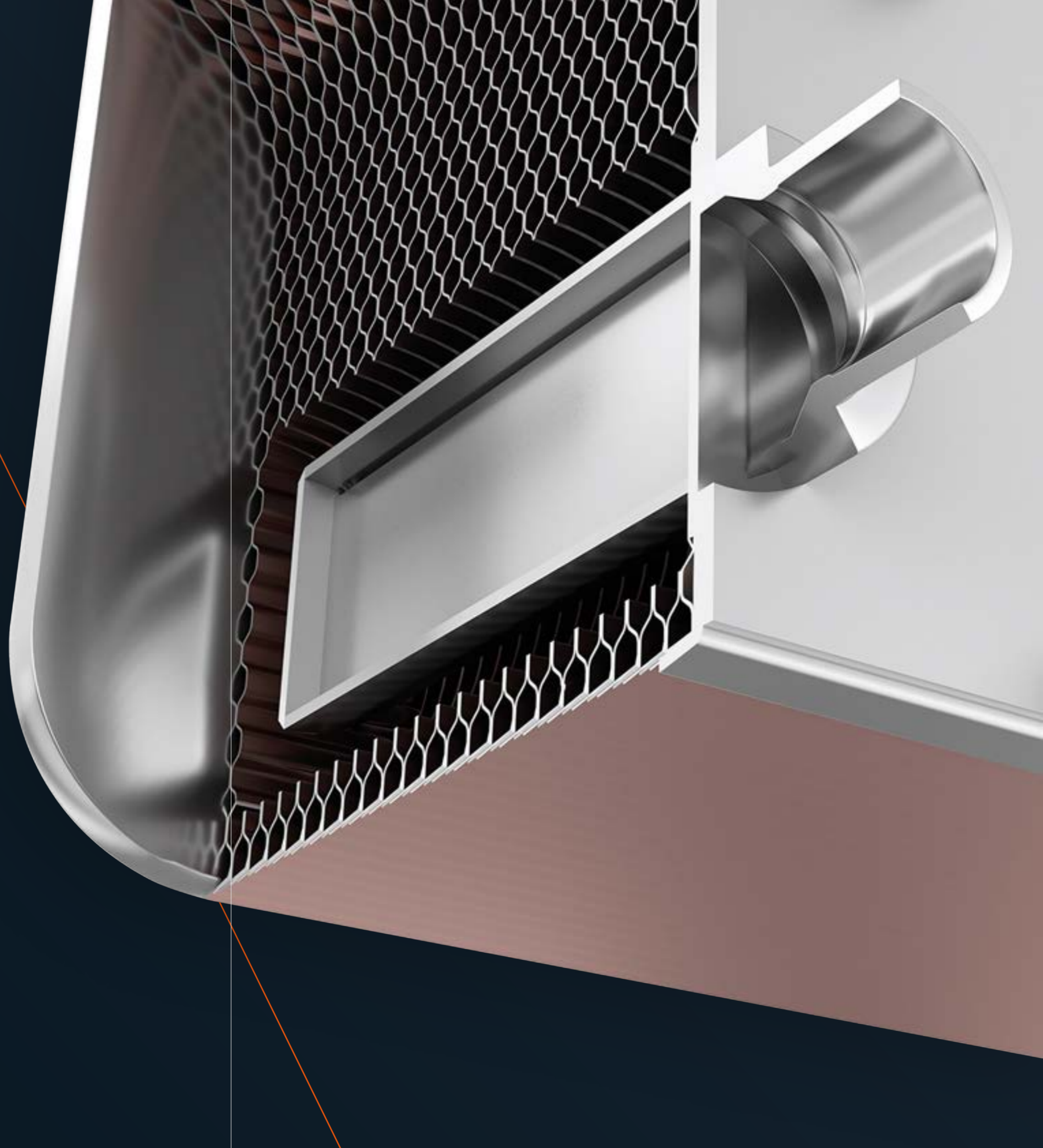



EXEMPLAR DESIGNATION

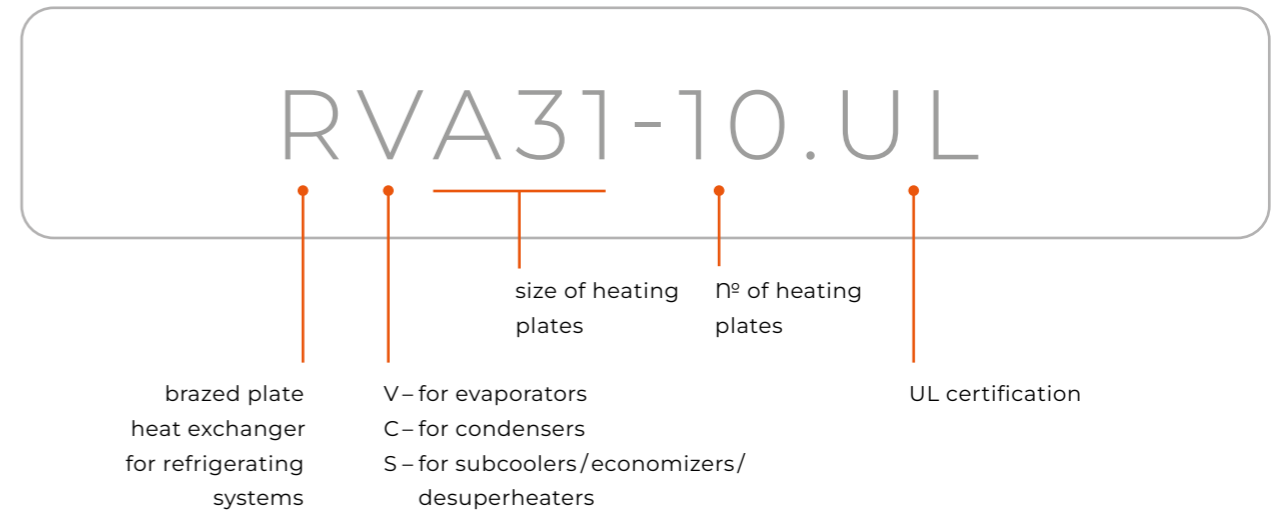

PRODUCT LINE



TECHNICAL DATA

STANDARD LOCATION OF CONNECTIONS

(DEPENDING ON WHETHER IT IS EVAPORATOR OR CONDENSER)

- K 4 / K 1** — inlet /outlet of refrigerant
- K 3 / K 2** — inlet /outlet of water or glycol

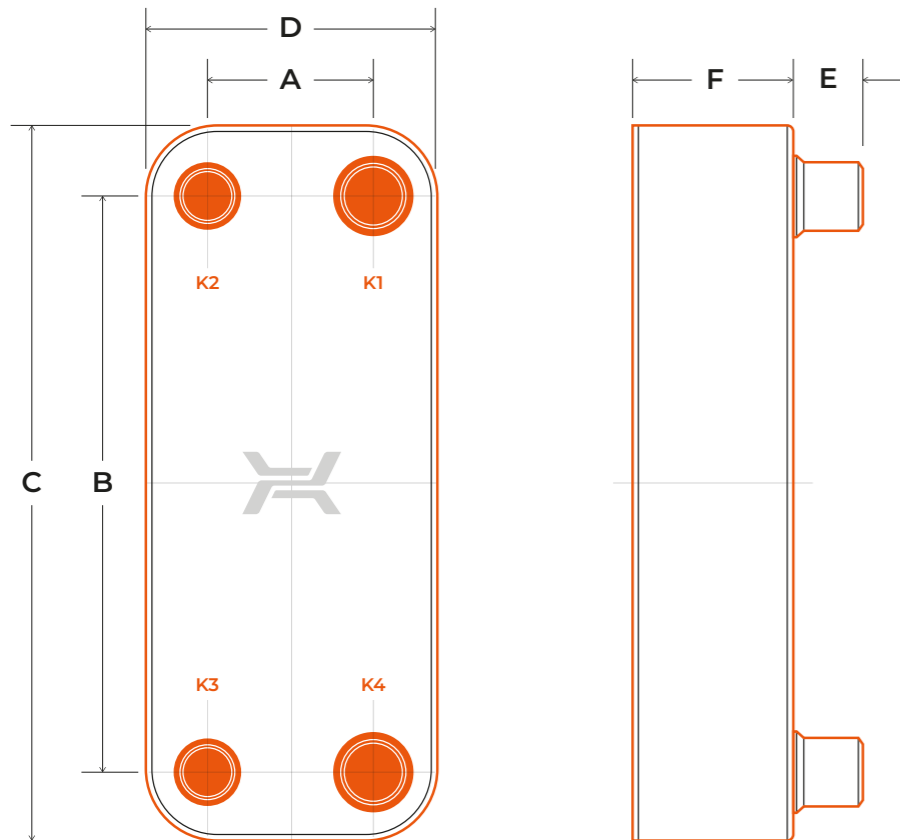

MATERIALS

- STAINLESS STEEL
- STAINLESS BRAZING
- COPPER BRAZING

EXEMPLARY MEDIA

REFRIGERANT SIDE

- R32, R452B, R454B, R1234ZE, R290, R410

OTHER SIDE

- WATER
- PROPYLENE GLYCOL SOLUTIONS
- GROUP II FLUIDS
- OTHER (CONSULT THE MANUFACTURER)

WORKING PARAMETERS

MAX. TEMPERATURE — 302°F

MIN. TEMPERATURE — -319°F

MAX. PRESSURE

- REFRIGERANT SIDE — 653 PSI
- WATER, GLYCOL SIDE — 363 PSI
- R LUNA — 363 PSI

TECHNICAL PARAMETERS

Type	Dimensions						Weight
	A	B	C	D	E	F	
	in	in	in	in	in	in	lb

EVAPORATORS

RVA14	1.7	6.5	8.0	3.2	0.6	0.43 + 0.09 × NP	1.54 + 0.11 × NP
RVA22	1.7	10.2	11.8	3.2	0.6	0.43 + 0.09 × NP	1.98 + 0.16 × NP
RVA34	1.7	17.0	18.5	3.2	0.6	0.43 + 0.09 × NP	2.87 + 0.26 × NP
RVB31	2.7	9.1	11.3	4.8	1.1	0.47 + 0.09 × NP	3.75 + 0.25 × NP
RVB47	2.7	14.2	16.4	4.8	1.1	0.47 + 0.09 × NP	5.07 + 0.37 × NP
RVB60	2.7	18.9	21.2	4.9	1.1	0.51 + 0.09 × NP	6.17 + 0.48 × NP
RVB60(X)	2.7	18.9	21.2	4.9	1.1	0.51 + 0.08 × NP	6.17 + 0.48 × NP
RVC110	6.7	14.9	18.3	10.2	1.1	0.55 + 0.09 × NP	27.6 + 0.9 × NP
RVC170	6.7	23.6	27.1	10.2	1.1	0.55 + 0.09 × NP	39.57 + 1.36 × NP
RVM110	3.6	20.5	24.4	7.5	1.1	0.55 + 0.1 × NP	30.64 + 0.9 × NP
RVM110(X)	3.6	20.5	24.4	7.6	1.1	0.55 + 0.08 × NP	30.64 + 0.9 × NP
RVD235	8.0	26.9	31.0	12.2	4.49	0.67 + 0.09 × NP	99.34 + 1.99 × NP
RVE400	9.5	33.9	39.7	15.2	4.5	0.75 + 0.11 × NP	179.9 + 13.59 × NP

CONDENSERS

RCA14	1.7	6.5	8.0	3.2	0.6	0.43 + 0.09 × NP	1.54 + 0.11 × NP
RCA22	1.7	10.2	11.8	3.2	0.6	0.43 + 0.09 × NP	1.98 + 0.16 × NP
RCA34	1.7	17.0	18.5	3.2	0.6	0.43 + 0.09 × NP	2.87 + 0.26 × NP
RCB31	2.7	9.1	11.3	4.8	1.1	0.47 + 0.09 × NP	3.75 + 0.25 × NP
RCB47	2.7	14.2	16.4	4.8	1.1	0.47 + 0.09 × NP	5.07 + 0.37 × NP
RCB60	2.7	18.9	21.2	4.9	1.1	0.51 + 0.09 × NP	6.17 + 0.48 × NP
RCB60(X)	2.7	18.9	21.2	4.9	1.1	0.51 + 0.08 × NP	6.17 + 0.48 × NP
RCC110	6.7	14.9	18.3	10.2	1.1	0.55 + 0.09 × NP	27.6 + 0.9 × NP
RCC170	6.7	23.6	27.1	10.2	1.1	0.55 + 0.09 × NP	39.57 + 1.36 × NP
RCM110	3.6	20.5	24.4	7.5	1.1	0.55 + 0.1 × NP	30.64 + 0.9 × NP
RCM110(X)	3.6	20.5	24.4	7.6	1.1	0.55 + 0.08 × NP	30.64 + 0.9 × NP
RCD235	8.0	26.9	31.0	12.2	4.49	0.67 + 0.09 × NP	99.34 + 1.99 × NP
RCE400	9.5	33.9	39.7	15.2	4.5	0.75 + 0.11 × NP	179.9 + 3.59 × NP

SUBCOOLERS / ECONOMIZERS / DESUPERHEATERS

RSA14	1.7	6.5	8.0	3.2	0.6	0.43 + 0.09 × NP	1.54 + 0.11 × NP
RSA22	1.7	10.2	11.8	3.2	0.6	0.43 + 0.09 × NP	1.98 + 0.16 × NP
RSA34	1.7	17.0	18.5	3.2	0.6	0.43 + 0.09 × NP	2.87 + 0.26 × NP
RSB31	2.7	9.1	11.3	4.8	1.1	0.47 + 0.09 × NP	3.75 + 0.25 × NP
RSB47	2.7	14.2	16.4	4.8	1.1	0.47 + 0.09 × NP	5.07 + 0.37 × NP
RVB60	2.7	18.9	21.2	4.9	1.1	0.51 + 0.09 × NP	6.17 + 0.48 × NP
RVB60(X)	2.7	18.9	21.2	4.9	1.1	0.51 + 0.08 × NP	6.17 + 0.48 × NP
RVC110	6.7	14.9	18.3	10.2	1.1	0.55 + 0.09 × NP	27.6 + 0.9 × NP
RVC170	6.7	23.6	27.1	10.2	1.1	0.55 + 0.09 × NP	39.57 + 1.36 × NP
RVM110	3.6	20.5	24.4	7.5	1.1	0.55 + 0.1 × NP	30.64 + 0.9 × NP
RVM110(X)	3.6	20.5	24.4	7.6	1.1	0.55 + 0.08 × NP	30.64 + 0.9 × NP
RVD235	8.0	26.9	31.0	12.2	4.49	0.67 + 0.09 × NP	99.34 + 1.99 × NP
RVE400	9.5	33.9	39.7	15.2	4.5	0.75 + 0.11 × NP	179.9 + 3.59 × NP

NP – number of plates | dim. F±/3%

All dimensions and technical data are approximate only and may be changed without further notice.

COOLING CAPACITY TABLE FOR LOW POWER INSTALLATIONS

EVAPORATOR [d_T GROUND SOURCE =5K]

[d_T INSTALLATION =10°F]

39/44,4°F - 54/44°F						105/101,4°F - 85/95°F					
R32	R452B	R454B	R1234ZE	R290	R410	R32	R452B	R454B	R1234ZE	R290	R410
0,5	RA34-10	RA34-10	RA34-10	RA34-10	RA34-10	0,5	RA22-10	RA14-20	RA14-20	RA22-10	RA14-20
0,75	RA34-20	RA34-10	RA34-10	RA34-20	RA22-30	0,75	RA34-10	RA34-10	RA34-10	RA34-10	RA34-10
1	RA34-20	RA34-20	RA34-20	RA34-20	RA34-20	1	RA34-10	RA34-10	RA34-10	RA34-10	RA34-10
1,5	RA34-20	RA34-20	RA34-20	RA34-30	RA34-20	1,5	RA34-10	RA22-30	RA22-30	RA34-10	RA34-10
2	RA34-30	RA34-30	RA34-30	RA34-40	RA34-30	2	RA22-30	RA34-20	RA34-20	RA22-30	RA34-20
2,5	RA34-30	RA34-30	RA34-30	RA34-60	RA34-30	2,5	RA34-20	RA34-30	RA34-20	RA34-20	RA34-20
3	RA34-40	RA34-40	RA34-30	RB60-40H	RA34-40	3	RA34-20	RA34-30	RA34-30	RA34-20	RA34-20
3,5	RA34-50	RA34-40	RA34-40	RB60-40H	RB60-30H	3,5	RA34-30	RA34-30	RA34-30	RA34-30	RA34-30
4	RB60-30H	RA34-50	RA34-50	RB60-50H	RB60-30H	4	RA34-30	RA34-40	RA34-30	RA34-30	RA34-30
5	RB60-40H	RB60-40H	RB60-40H	RB60-70H	RB60-40H	5	RA22-60	RA34-40	RA34-40	RA34-40	RA34-40
6	RB60-50H	RB60-40H	RB60-40H	RM110-40-2	RB60-50H	6	RB47-40	RB60-30H	RB60-30H	RB47-40H	RB60-30H
7,5	RB60-70H	RB60-60H	RB60-60H	RM110-50-2	RM110-30H	7,5	RB47-40H	RB60-40H	RB60-40	RB60-30	RB47-50H

29/34,4°F - 44/34°F						125/121,4°F - 105/115°F					
R32	R452B	R454B	R1234ZE	R290	R410	R32	R452B	R454B	R1234ZE	R290	R410
0,5	RA34-10	RA34-10	RA34-10	RA22-30	RA34-10	0,5	RA22-10	RA14-20	RA14-20	RA22-10	RA14-20
0,75	RA34-20	RA34-10	RA34-10	RA34-20	RA34-20	0,75	RA34-10	RA34-10	RA34-10	RA34-10	RA34-10
1	RA34-20	RA34-20	RA34-20	RA34-20	RA34-20	1	RA34-10	RA34-10	RA34-10	RA34-10	RA34-10
1,5	RA34-20	RA34-20	RA34-20	RA34-30	RA34-20	1,5	RA22-30	RA22-30	RA22-30	RA34-10	RA22-30
2	RA34-30	RA34-30	RA34-30	RA34-50	RA34-30	2	RA34-20	RA34-20	RA34-20	RA34-20	RA34-20
2,5	RA34-40	RA34-30	RA34-30	RB60-30H	RA34-40	2,5	RA34-20	RA34-30	RA34-20	RA34-20	RA34-20
3	RA34-50	RA34-40	RA34-40	RB60-40H	RA34-50	3	RA34-30	RA34-30	RA34-30	RA34-20	RA34-30
3,5	RA34-60	RA34-50	RA34-50	RB60-50H	RB60-30H	3,5	RA34-30	RA34-30	RA34-30	RA34-30	RA34-30
4	RB60-40H	RB60-30H	RA34-60	RB60-60H	RB60-40H	4	RA34-30	RA34-40	RA34-40	RA34-30	RA34-30
5	RB60-40H	RB60-40H	RB60-40H	RB60-80H	RB60-40H	5	RA34-40	RA34-40	RA34-40	RA34-40	RA34-40
6	RB60-50H	RB60-50H	RB60-50H	RM110-40H	RB60-60H	6	RB60-30H	RB47-50H	RB60-30H	RB47-40H	RB60-30H
7,5	RB60-80H	RB60-70H	RB60-60H	RM110-50H	RM110-30H	7,5	RB60-40	RB60-40H	RB60-40H	RB47-50H	RB60-40H

18/23,4°F - 32/23°F						145/141,4°F - 125/135°F					
R32	R452B	R454B	R1234ZE	R290	R410	R32	R452B	R454B	R1234ZE	R290	R410
0,5	RA34-20	RA34-20	RA34-20	RA34-20	RA34-20	0,5	RHA22-10	RHA14-20	RHA14-20	RA22-10	RA34-10
0,75	RA34-20	RA34-20	RA34-20	RA34-30	RA34-20	0,75	RHA34-10	RHA34-10	RHA34-10	RA34-10	RA34-10
1	RA34-30	RA34-20	RA34-20	RA34-40	RA34-30	1	RHA34-10	RHA22-20	RHA22-20	RA34-10	RA34-10
1,5	RA34-40	RA34-30	RA34-30	RB60-40-1	RA34-40	1,5	RHA34-10	RHA22-30	RHA22-30	RA34-10	RA34-10
2	RA34-50	RA34-40	RA34-40	RB60-50H	RA34-50	2	RHA22-30	RHA34-20	RHA34-20	RA34-20	RHA34-20
2,5	RB60-40H	RA34-60	RA34-60	RB60-60H	RB60-40H	2,5	RHA34-20	RHA34-30	RHA34-30	RA34-20	RHA34-20
3	RB60-50H	RB60-40H	RB60-40H	RB60-90H	RB60-40H	3	RHA34-20	RHA34-30	RHA34-30	RA34-20	RHA34-20
3,5	RB60-50H	RB60-50H	RB60-50H	RM110-40H	RB60-50H	3,5	RHA34-30	RHA34-40	RHA34-40	RA34-30	RHA34-30
4	RB60-60H	RB60-50H	RB60-50H	RM110-40H	RB60-60H	4	RHA34-30	RHA34-40	RHA34-40	RA34-30	RHA34-30
5	RM110-40H	RB60-70H	RB60-70H	RM110-50H	RM110-40H	5	RHA34-40	RHA34-50	RHA34-50	RA34-40	RHA34-40
6	RM110-50H	RB60-100H	RB60-100H	RM110-60H	RM110-40H	6	RHB47-40	RHB47-50H	RHB47-50H	RB47-40H	RHB60-30H
7,5	RM110-60H	RM110-50H	RM110-50H	RM110-80H	RM110-50H	7,5	RHB47-40H	RHB60-50	RHB47-60H	RB47-50H	RHB60-40H

EVAPORATOR

MEDIUM
EVAPORATION TEMP.
— 39/29/19°F
OVERHEATING — 3K

WATER
54/44°C - 44/34°F

PG35
32/23°F, DPMAX<30KPA

CONDENSER

MEDIUM
CONDENSING TEMP.
— 105/125/145°F
OVERCOOLING — 2K

WATER
85/95 - 105/115 - 125/135°F

DPMAX<30KPA

ECONOMIZER

	R410A
4 kW	RSA14-10
6 kW	RSA14-10
9 kW	RSA14-20
12 kW	RSA14-30
16 kW	RSB31-15
20 kW	RSB31-20
25 kW	RSB31-20
35 kW	RSB31-30
50 kW	RSB31-40
60 kW	RSB31-60

COOLING CAPACITY TABLE FOR HIGH POWER INSTALLATIONS

EVAPORATOR [d_T GROUND SOURCE =5K]

CONDENSER [d_T INSTALLATION =10°F]

39/44,4°F - 54/44°F						105/101,4°F - 85/95°F					
R32	R452B	R454B	R1234ZE	R290	R410	R32	R452B	R454B	R1234ZE	R290	R410
10	RM110-40H	RM110-40H	RM110-30H	RM110-60H	RM110-40H	10	RB60-40	RB60-50H	RB60-50H	RB60-40	RB60-50
12,5	RM110-50H	RM110-40H	RM110-40H	RM110-70H	RM110-50H	12,5	RM110-30	RM110-40	RM110-40	RM110-30	RM110-40
15	RM110-60H	RM110-50H	RM110-50H	RM110-90H	RM110-60H	15	RM110-40	RM110-40H	RM110-40H	RM110-40	RM110-40H
20	RM110-70H	RM110-60H	RM110-60H	RM110-130H	RM110-70H	20	RM110-50	RM110-60	RM110-60	RM110-50	RM110-60
25	RM110-90H	RM110-80H	RM110-80H	RD235-80	RM110-90H	25	RM110-50	RM110-70H	RM110-70	RM110-50	RM110-70
30	RM110-110H	RM110-90H	RM110-90H	RD235-100	RM110-120H	30	RM110-60	RM110-80H	RM110-80	RM110-60	RM110-80
35	RM110-150H	RM110-120H	RM110-120H	RD235-130	RD235-70	35	RM110-70	RM110-100	RM110-100	RM110-70	RM110-100
40	RD235-80	RD235-70	RD235-70	—	RD235-80	40	RM110-90	RM110-120	RM110-110	RM110-90	RM110-100
50	RD235-110	RD235-90	RD235-90	—	RD235-120	50	RM110-110	RM110-150	RM110-140	RM110-110	RM110-130
60	—	RD235-130	RD235-120	—	—	60	RM110-150	RC170-130	RC170-130	RM110-150	RC170-130
70	—	—	—	—	—	70	RD235-100	RD235-100	RD235-100	RD235-100	RD235-100
80	—	—	—	—	—	80	RD235-120	RD235-120	RD235-120	RD235-120	RD235-120

29/34,4°F - 44/34°F						125/121,4°F - 105/115°F					
R32	R452B	R454B	R1234ZE	R290	R410	R32	R452B	R454B	R1234ZE	R290	R410
10	RM110-40H	RM110-40H	RM110-40H	RM110-70H	RM110-40H	10	RB60-50	RB60-60	RB60-50H	RB47-60H	RB60-50H
12,5	RM110-50H	RM110-50H	RM110-50H	RM110-80H	RM110-50H	12,5	RM110-40	RM110-40	RM110-40	RM110-30	RM110-40
15	RM110-60H	RM110-50H	RM110-50H	RM110-100H	RM110-60H	15	RM110-40	RM110-40H	RM110-40H	RM110-40	RM110-40H
20	RM110-80H	RM110-70H	RM110-70H	RD235-70	RM110-80H	20	RM110-60	RM110-60H	RM110-60	RM110-50	RM110-60
25	RM110-100H	RM110-80H	RM110-80H	RD235-90	RM110-100H	25	RM110-70	RM110-70H	RM110-70H	RM110-60	RM110-70H
30	RM110-130H	RM110-110H	RM110-110H	RD235-120	RM110-150H	30	RM110-80	RM110-80H	RM110-80H	RM110-70	RM110-80H
35	RD235-80	RM110-140H	RM110-140H	—	RD235-80	35	RM110-90	RM110-100H	RM110-100H	RM110-80	RM110-100
40	RD235-90	RD235-80	RD235-80	—	RD235-90	40	RM110-110	RM110-110H	RM110-110H	RM110-90	RM110-110H
50	RD235-130	RD235-100	RD235-100	—	RD235-120	50	RM110-130	RM110-150	RM110-150	RM110-110	RM110-130
60	—	—	—	—	—	60	RC170-130	RC170-130	RC170-130	RM110-150	RC170-130
70	—	—	—	—	—	70	RD235-100	RD235-100	RD235-100	RD235-100	RD235-100
80	—	—	—	—	—	80	RD235-120	RD235-120	RD235-120	RD235-120	RD235-120

18/23,4°F - 32/23°F						145/141,4°F - 125/135°F					
R32	R452B	R454B	R1234ZE	R290	R410	R32	R452B	R454B	R1234ZE	R290	R410
10	RM110-70H	RM110-60H	RM110-60H	RM110-100H	RM110-70H	10	RHB60-40	RHB60-60	RHB60-60	RB47-60H	RB60-50
12,5	RM110-90H	RM110-80H	RM110-80H	RM110-140H	RM110-80H	12,5	RHC110-40	RHC110-50	RHC110-50	RM110-30	RHC110-50
15	RM110-110H	RM110-90H	RM110-90H	RD235-80	RM110-100H	15	RHC110-50	RHC110-60	RHC110-60	RM110-40	RHC110-60
20	RM110-150H	RM110-120H	RM110-120H	RD235-100	RD235-70	20	RHC110-60	RHC110-80	RHC110-80	RM110-50	RHC110-80
25	RD235-90	RD235-80	RD235-80	—	RD235-90	25	RHC110-80	RHC110-100	RHC110-100	RM110-60	RHC110-100
30	RD235-110	RD235-90	RD235-90	—	RD235-110	30	RHC110-90	—	—	RM110-60	RM110-80
35	—	RD235-110	RD235-110	—	—	35	RHC110-100	—	—	RM110-70	RM110-90
40	—	—	—	—	—	40	—	—	—	RM110-80	RM110-100
50	—	—	—	—	—	50	—	—	—	RM110-110	RM110-120
60	—	—	—	—	—	60	—	—	—	RM110-150	RM110-150
70	—	—	—	—	—	70	—	—	—	RD235-100	RD235-100
80	—	—	—	—	—	80	—	—	—	RD235-120	RD235-120

EVAPORATOR

MEDIUM
EVAPORATION TEMP.
— 39/29/19°F
OVERHEATING — 3K

WATER
54/44°C - 44/34°F

PG35
32/23°F, DPMAX<30KPA

CONDENSER

MEDIUM
CONDENSING TEMP.
— 105/125/145°F
OVERCOOLING — 2K

WATER
85/95 - 105/115 - 125/135°F

THE HIGH-PERFORMANCE PLATE

Our product range of brazed plate heat exchangers stands out for its extensive assortment and adaptable features, offering unmatched diversity in size, brazing material, connection types, flow arrangements, and accessory options. Now, we have gone one step further and created a reinforced heat exchanger dedicated to cooling and heating solutions. These ultra-efficient heat exchangers feature special heating plates "X", providing enhanced heat transfer efficiency and increased turbulence flow of the medium. Consequently, this leads to increased thermal efficiency, lower investment costs, and a reduced footprint.

EXEMPLAR DESIGNATION

2S – 2-pass with 6 connections
 2 – 2-pass with 4 connections
 no letter – 1-pass

LB60-60X-2S-3/4".UM

brazed plate heat exchanger
 size of plates
 n° of plates
 high-performance plate
 type and size of connections
 ASME certification

RVB60-100X.UL

brazed plate heat exchanger
 V – for evaporators
 C – for condensers
 S – for subcoolers / economizers / desuperheaters
 size of plates
 n° of plates
 high-performance plate
 UL certification

ADVANTAGES



ULTRA-EFFICIENT HEAT EXCHANGER FOR HEATING AND COOLING



INCREASED FLOW TURBULENCE OF THE MEDIUM



OPTIMIZED FLUID FLOW



REDUCED REFRIGERANT USAGE



ENHANCED THERMAL EFFICIENCY

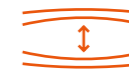

REINFORCED CONSTRUCTION FOR HIGHER PRESSURES



INCREASED HEAT EXCHANGE AREA



LOW CARBON FOOTPRINT

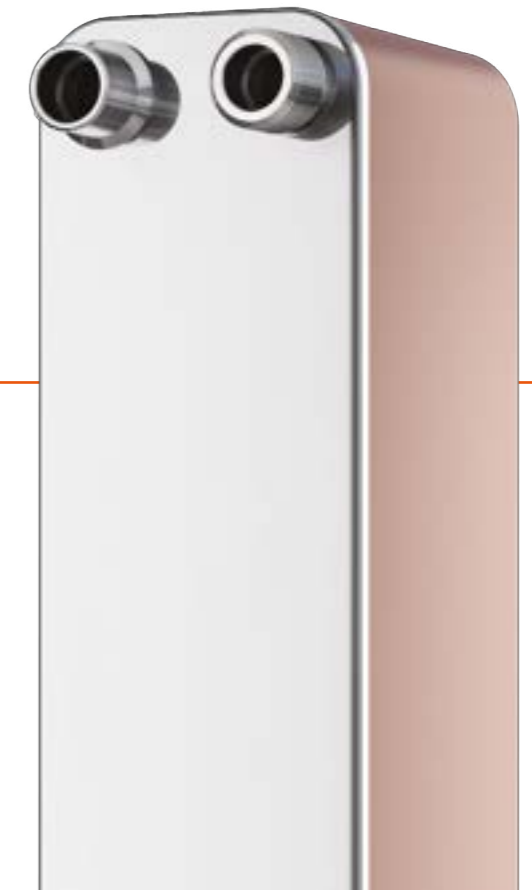

SafePLATE

DOUBLE WALL HEAT EXCHANGERS

DESIGNED FOR APPLICATIONS WHERE IT IS CRUCIAL TO DOUBLE-PROTECT MEDIA FROM MIXING AND QUICKLY DETECT ANY POTENTIAL INTERNAL LEAK.

APPLICATION



TAP WATER
HEATING SYSTEMS



CENTRAL
HEATING SYSTEMS



TECHNOLOGICAL
SYSTEMS

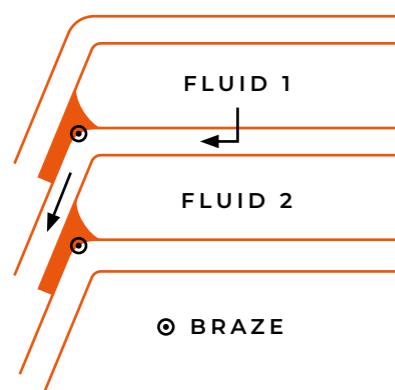

DOUBLE-WALL SYSTEM

In case of failure, either corrosion or pressure induced, special arrangement of double walls and interspace in sidewalls helps to prevent potential mixing of working media and allows the leakage to be visually detected.

ADVANTAGES



EFFECTIVE LEAK DETECTION



HELPS TO PREVENT POTENTIAL
MIXING OF WORKING MEDIA



EXEMPLAR DESIGNATION

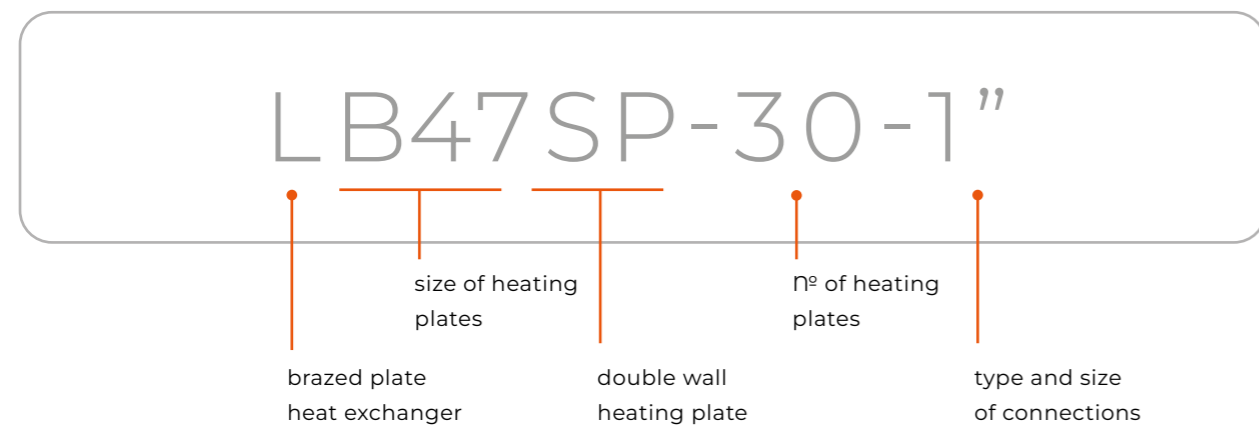

PRODUCT LINE



TECHNICAL DATA

MATERIALS

- STAINLESS STEEL
- COPPER BRAZING

EXEMPLARY MEDIA

- WATER
- PROPYLENE GLYCOL SOLUTIONS
- GROUP II FLUIDS
- OTHER (CONSULT THE MANUFACTURER)

WORKING PARAMETERS

MAX. TEMPERATURE — 446°F

MIN. TEMPERATURE — -319°F

MAX. PRESSURE — 362 PSI

STANDARD LOCATION OF CONNECTIONS

K1 / K4 — inlet / outlet hot side **K1 / K4** — inlet / outlet hot side

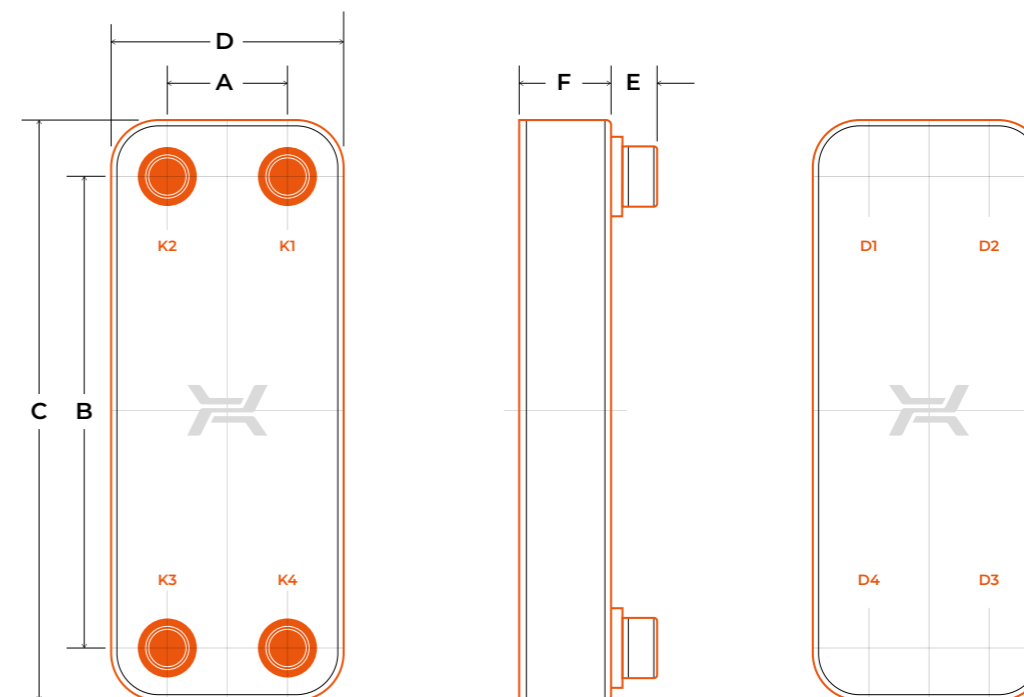

Double-wall heat exchangers have been designed to prevent media from mixing and enable quick leak detection. However, it should be remembered that no heat exchangers of this type guarantee the reliability of such operation and cannot be used instead of other safety systems.

TECHNICAL PARAMETERS

Type	Dimensions						max N° of plates	Mass
	A	B	C	D	E	F		
	in	in	in	in	in	in	lb	
LB47SP	2.68	14.17	16.46	4.93	1.1	0.43 + 0.10 × NP	100	8.07 + 0.57 × NP
LC140SP	6.69	19.29	22.83	10.23	1.5	0.43 + 0.10 × NP	150	20.08 + 1.81 × NP

NP – number of plates | dim. F+/-3%

All dimensions and technical data are approximate only and may be changed without further notice.

L ULTRA

The L ULTRA brazed plate heat exchanger combines the optimal efficiency of brazed plate heat exchangers with the resistance to high pressures. This new series features additional pressure plates in the form of a steel frame. The units can be brazed with either copper or stainless materials. Their excellent efficiency under high-pressure conditions makes them ideal for applications involving the use of CO₂.

APPLICATION



CO₂ HEAT PUMPS



CASCADE REFRIGERATION SYSTEMS



CO₂ CHILLERS



TRANSCRITICAL CO₂ SYSTEMS



POLYMER PRODUCTION



PETROCHEMICAL PROCESSES

ADVANTAGES



RESISTANCE TO HIGH WORKING PRESSURES



LOW MAINTENANCE



COMPACT SIZE



GASKET-FREE DESIGN



EASY INSTALATION



MANUFACTURED IN ACCORDANCE WITH ASME, PED, UL



LUNA™ OPTION AVAILABLE



MINIMAL SERVICE



RESISTANT TO HIGH PRESSURE UP TO 2030 PSI

TECHNICAL DATA

STANDARD LOCATION OF CONNECTIONS

- K1 / K4** — inlet / outlet hot side
- K3 / K2** — inlet / outlet cold side

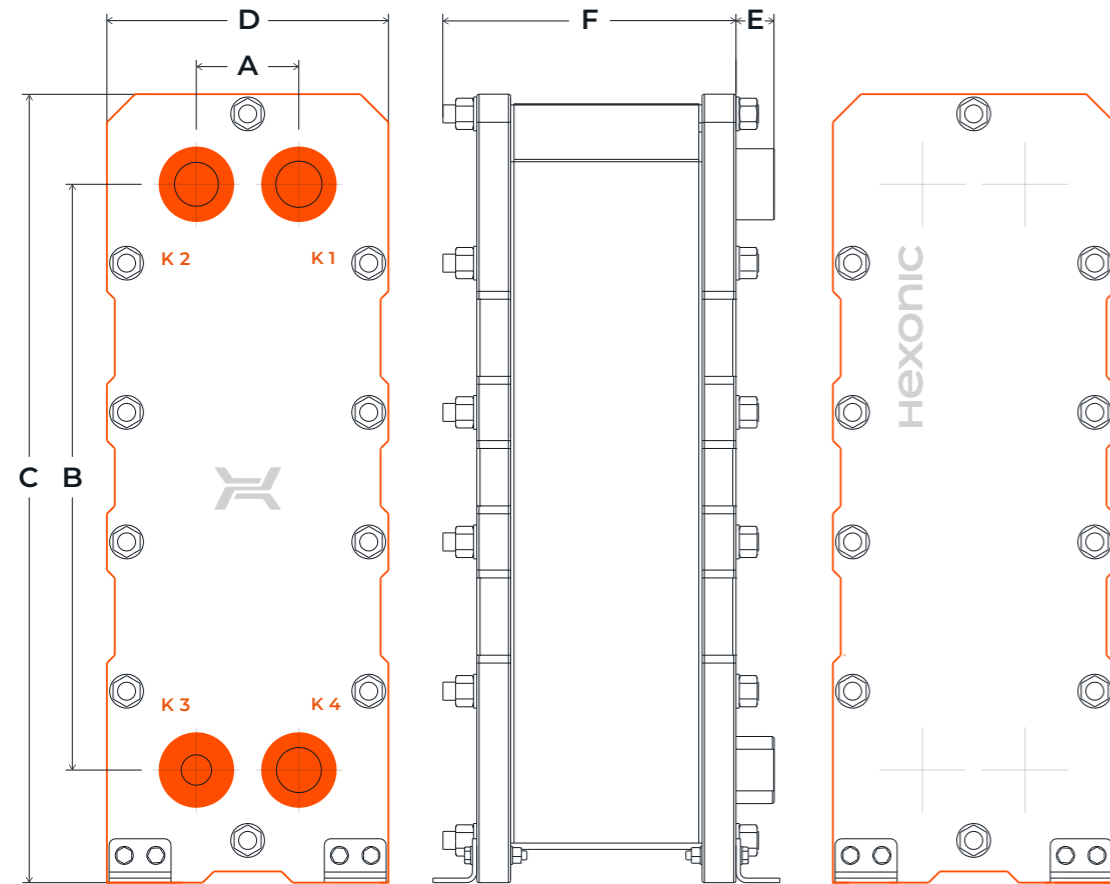

EXEMPLAR DESIGNATION

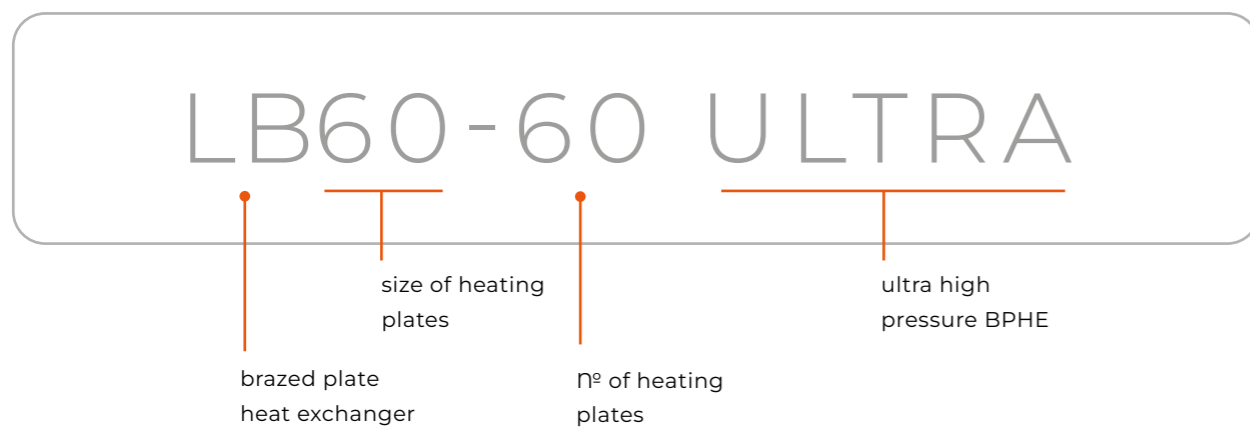

MATERIALS

- HEATING PLATES MATERIALS: STAINLESS STEEL WITH COPPER OR STAINLESS BRAZING
- FRONT AND REAR PLATE MATERIALS: CARBON STEEL (CS)

WORKING PARAMETERS

- MAX. TEMPERATURE — 302°F
- MIN. TEMPERATURE — -40°F
- MAX. PRESSURE
 - L ULTRA — 2030 PSI
 - LUNA ULTRA — 1015 PSI

EXEMPLARY MEDIA

- CARBON DIOXIDE
- HYDROGEN
- INERT AND ACTIVE GASES
- HYDROCARBONS
- HYDRAULIC OILS
- PEROXIDES

TECHNICAL PARAMETERS

Type	Dimensions						max N° of plates	Mass lb
	A	B	C	D	E	F		
	in	in	in	in	in	in		
LB60 ULTRA	2.68	18.90	24.41	7.28	1.42	3.27 + 0.08 × NP	150	89.51 + 0.46 × NP
LM110 ULTRA	2.68	20.47	27.56	9.84	1.34	3.94 + 0.08 × NP	200	205.03 + 0.90 × NP
LD235 ULTRA	8.03	26.85	36.22	15.51	3.94	6.02 + 0.08 × NP	280	633.17 + 1.83 × NP

All dimensions and technical data are approximate only and may be changed without further notice. Mass is given for 1-pass heat exchangers.



TYPE AND SIZE OF CONNECTIONS

Type	External thread (NPT)	Internal thread (NPT)	Dual (external thread and soldering)	Victaulic	Flange	Soldering connection for R heat exchangers
LA	3/8", 1/2", 3/4"	3/8", 1/2", 3/4"	3/8", 1/2", 3/4"			1/4", 3/8", 1/2", 5/8", 3/4", 7/8"
LI		3/4"	3/4", 1"			
LH		3/4"	3/4", 1"			
LB	3/4", 1", 5/4"	3/4", 1", 5/4"	3/4", 1", 5/4"	3/4", 1", 5/4", 3/2"		1/4", 3/8", 1/2", 5/8", 3/4", 7/8", 1", 1 1/8", 1 3/8"
LM	2"		2"			7/8", 1 1/8", 1 3/8", 1 5/8", 2 1/8"
LC	5/4", 3/2", 2", 5/2"	1", 5/4", 3/2", 2"	5/4", 3/2", 2", 5/2"	3/2", 2", 5/2"	ANSI B16.5 2" CLASS 300 SORF	7/8", 1", 1 1/8", 1 3/8", 1 5/8", 2 1/8"
LD					ANSI B16.5 3" CLASS 300 SORF	1 1/8", 1 3/8", 1 5/8", 2 1/8", 2 5/8", 3 1/8", 3 5/8"
LE					ANSI B16.5 4" CLASS 300 SORF	2 1/8", 2 5/8", 3 1/8", 3 5/8"
LF					ANSI B16.5 6" CLASS 600 SORF	

*The same types and sizes of connections are used consistently across the LUNA, R, SP, and ULTRA options.

MOUNTING BRACKETS

MOUNTING BRACKETS ARE MANUFACTURED USING STAINLESS STEEL OR CARBON ZINC-PLATED STEEL



INSULATION

INSULATION MADE OF POLYURETHANE FOAM COVERED WITH ALUMINIUM (APFI)

- MAX. WORKING TEMPERATURE: 275°F
- THICKNESS: 1.18 IN
- THERMAL CONDUCTIVITY: 0.015 BTU/FT. HOUR°F



INSULATION MADE OF EXPANDED POLYPROPYLENE (EPPI) WITH ALUMINIUM (APFI)

- MAX. WORKING TEMPERATURE: 230°F
- THICKNESS: 1.10 IN
- THERMAL CONDUCTIVITY: 0.020 BTU/FT. HOUR°F



COLD INSULATION FOR R-LINE HEAT EXCHANGERS

- WORKING TEMPERATURE RANGE: -40°F TO 230°F
- THICKNESS: 0.787 IN
- THERMAL CONDUCTIVITY: 0.021 BTU/FT. HOUR°F



