

JAG

PLATE HEAT EXCHANGERS



JAG

NEW PLATE HEAT EXCHANGER

Driven by a passion for innovation, Hexonic has provided effective heat transfer solutions for most applications. Working closely with our customers, our team of experienced engineers focuses on inventing new products and solutions in search of the most efficient ways of heat transfer. Our team of experienced engineers driven by passion for innovation gained knowledge across diverse market segments.

From that passion a new product has been born – JAG Plate Heat Exchanger with inventive jagged pattern of a heating plate.

Breaking new ground solution brings not only enhanced flow turbulence but also increased heat exchange area. Together it gives more compact, lighter but most of all more efficient device which can be customized to your individual requirements. Highly efficient JAG Plate Heat Exchanger will become a long-life dependable solution for your applications.

APPLICATIONS

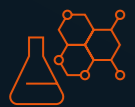

CHEMICAL INDUSTRY



FOOD & BEV INDUSTRY



HVAC-R



IRON AND STEEL INDUSTRY



PULP & PAPER INDUSTRY



MARINE INDUSTRY



POWER



PHARMACEUTICAL INDUSTRY



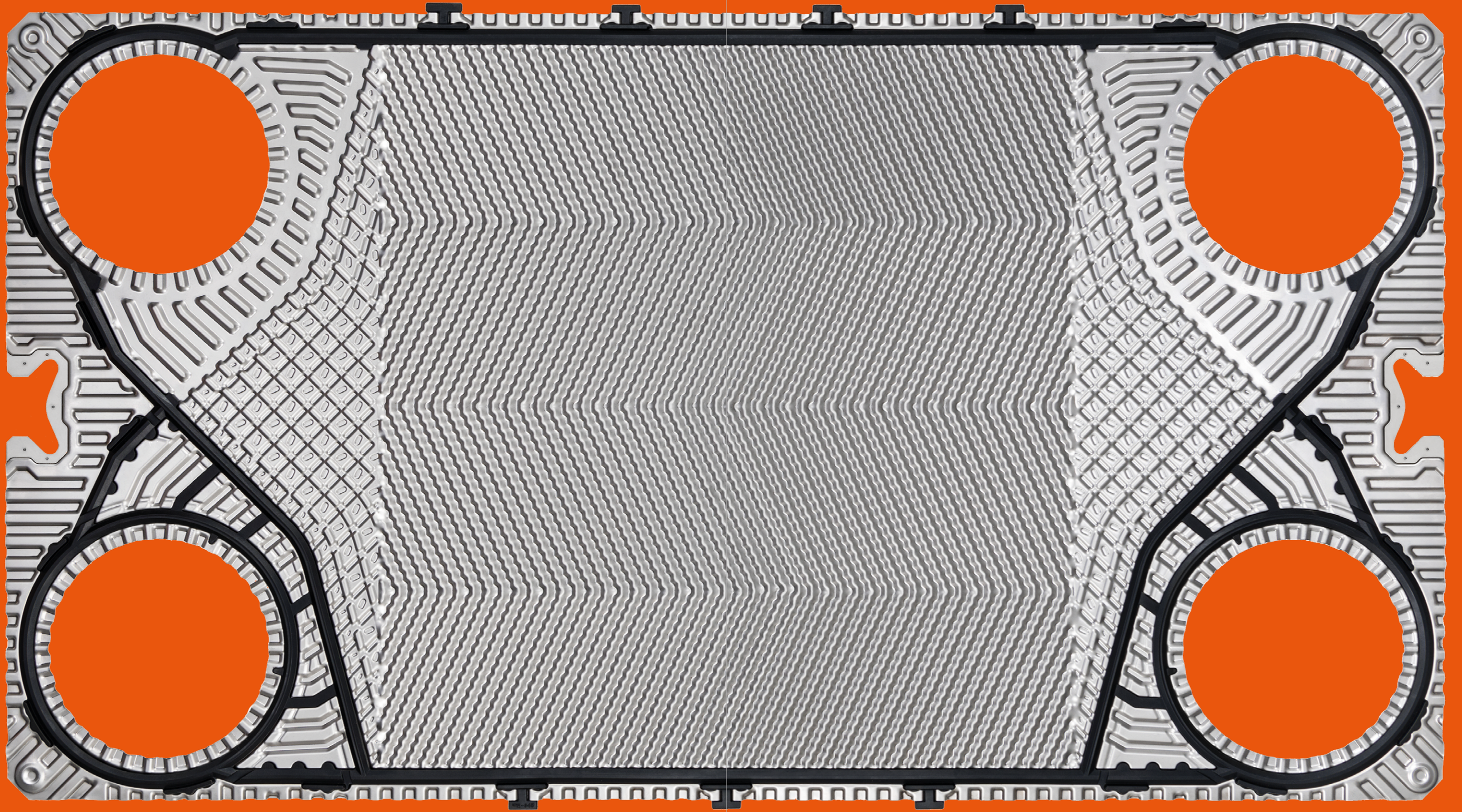

INGENIOUS PATTERN

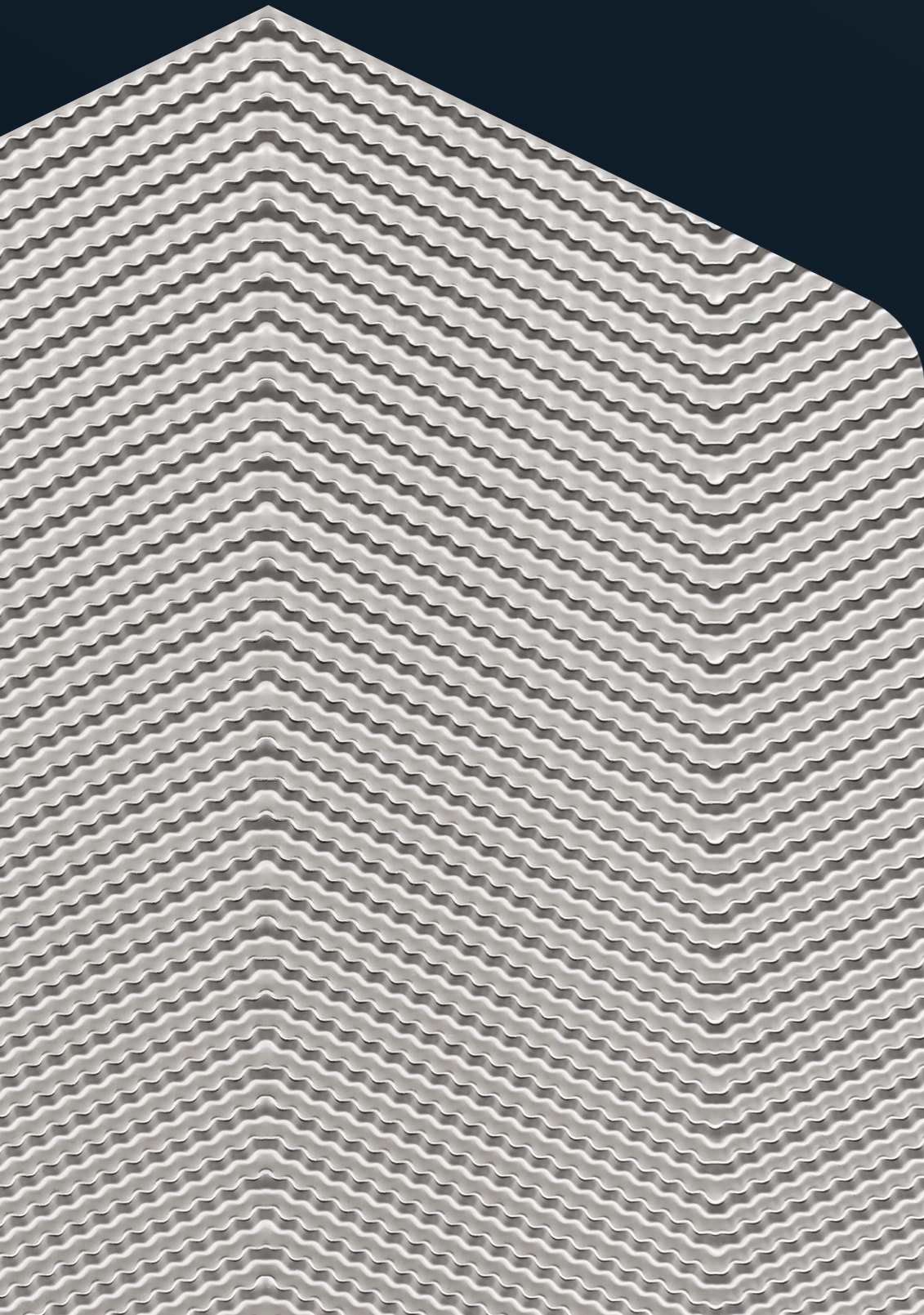

JAGGED
/ˈdʒɑːɡɪd/
WITH ROUGH, SHARP POINTS PROTRUDING

THE INNOVATIVE JAG DESIGN IS THE RESULT OF OVER SIX YEARS OF RESEARCH AND DEVELOPMENT.

In search of optimal strength and thermal characteristics of the JAG geometry, a series of computational fluid dynamic analyses were performed. Together with other calculations and tests of prototypes they allowed to determine the precise channel performance in a plate heat exchanger.

Final tests confirmed that designed by Hexonic innovative corrugation JAG pattern combined with specially modelled plate geometry delivers up to 10% higher efficiency than the standard one. It is designed to substantially increase heat exchange as the "jagged" channels boost flow turbulence which enhances heat transfer, and reduces fouling. Furthermore, the design brings a bigger exchange area and general pressure drop levels are reduced.

Ingenious JAG technology brings you cutting-edge solutions within one plate.



INNOVATIVE
CORRUGATION
DESIGN



UP TO 10% HIGHER
HEAT TRANSFER
EFFICIENCY



ENHANCED FLOW
TURBULENCE



UP TO 10% LOWER
PRESSURE DROP FOR
HIGH FLOW PATTERN



DECREASED
FOULING



INCREASED HEAT
EXCHANGE AREA



INCREASED PLATE
DURABILITY

JAG PLATE

REINVENTED

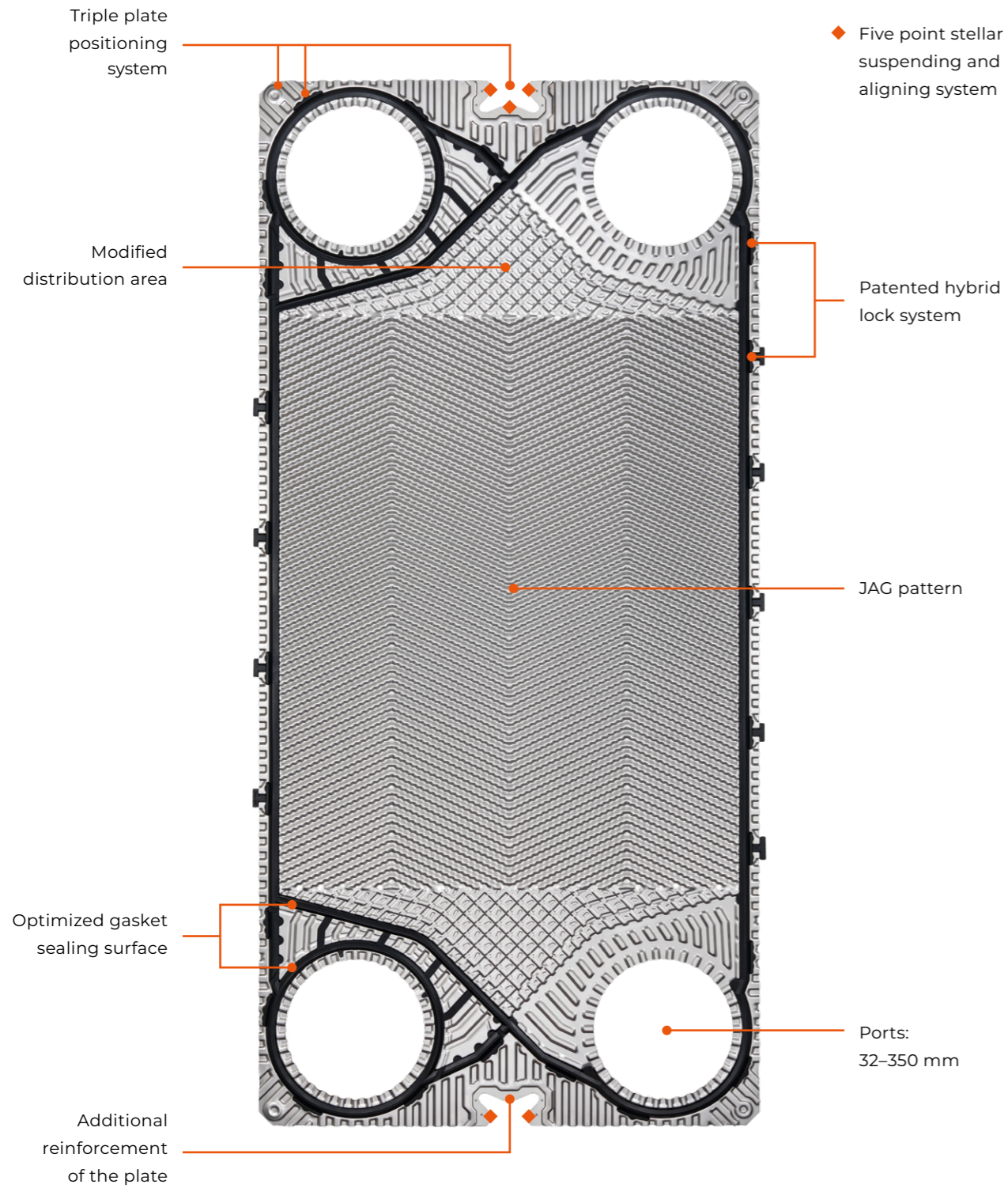

SPECIAL PLATE FEATURES

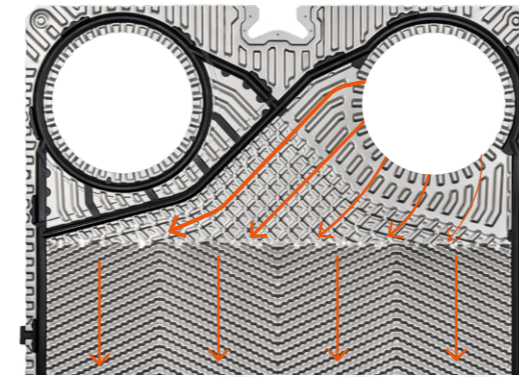

MODIFIED DISTRIBUTION AREA

Additionally corrugated distribution area is designed to enhance turbulent flow in the entrance part of the plate. It also allows even flow through the plate which increases heat transfer by optimal use of its surface area.

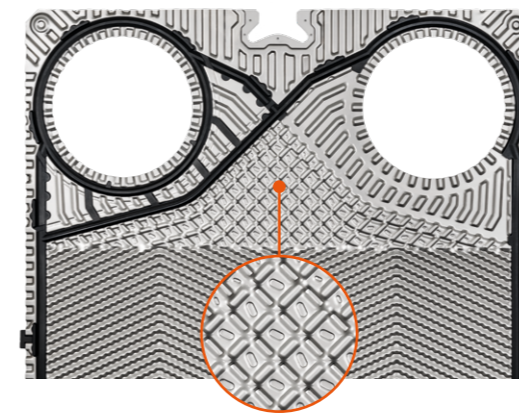
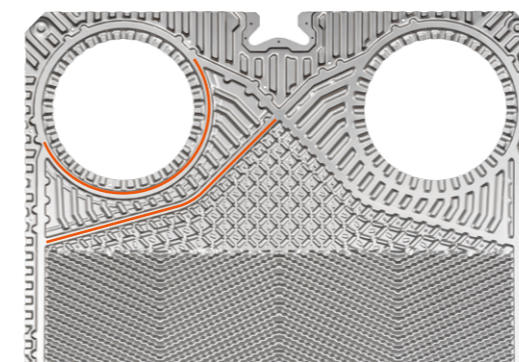

PLATE REINFORCEMENT

Specifically corrugated distribution area strengthens the plate and increases the stability of the whole construction.



OPTIMIZED GASKET SEALING SURFACE

Carefully designed groove together with specially modelled gasket makes the exchanger withstand high pressure.

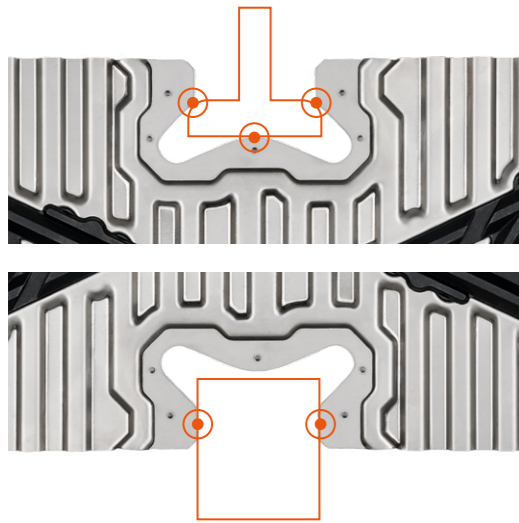

FIVE POINT STELLAR SUSPENDING AND ALIGNING SYSTEM

Five point suspending and aligning system ensures excellent alignment of the plates packet and guarantees correct sealing of the exchanger.

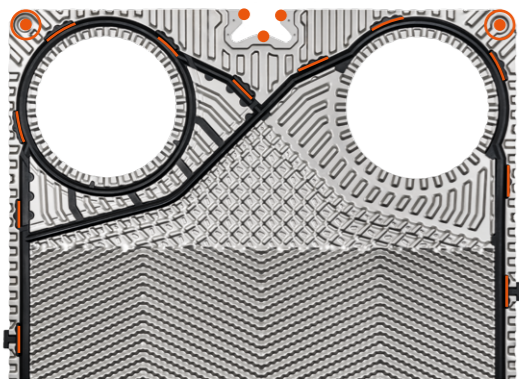

TRIPLE PLATE POSITIONING SYSTEM

Thanks to the three independent aligning systems the plates perfectly fit and therefore are secured from shaking or leaking. The system features:

- **GASKET ALIGNING SYSTEM**
special protruding elements align the plates in relation to one another
- **POINT LOCKING SYSTEM**
dedicated corrugated elements on the plate
- **STELLAR SUSPENDING SYSTEM**
alignment in position to the upper and lower bar.

THE FINITE ELEMENT METHOD ANALYSIS

The **Finite Element Method Analysis (FEM)** optimized the design of the JAG plate heat exchanger in terms of strength, mainly by improving the stress distribution on the cover plates and modifying the location of the fasteners, which contributed to the extension of the operating parameters.

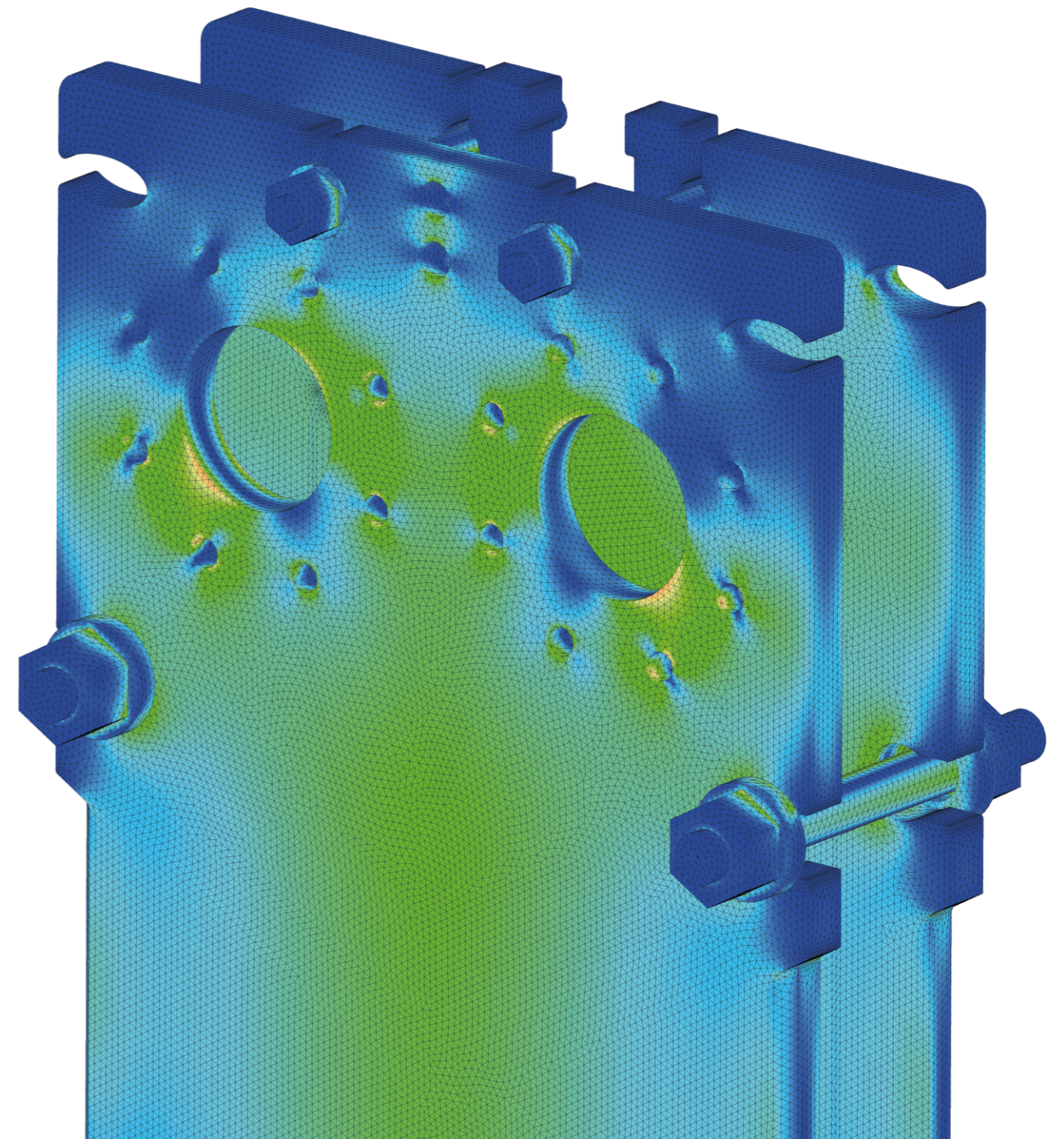



Plate&frame heat exchangers JAG are certified by AHRI liquid to liquid, which attests to their high quality and effectiveness in the heat exchange process. The AHRI certificate confirms that the product meets the technical and quality requirements that are placed in the HVACR (Heating, Ventilation, Air Conditioning, and Refrigeration) industry, ensuring that JAG heat exchangers are trustworthy and suitable for use in industrial or commercial processes.

THE AHRI CERTIFICATE CONFIRMS:



THE HIGH DEGREE OF EFFICIENCY OF AJF HEAT EXCHANGERS



THE INNOVATIVE THERMAL PROPERTIES OF HEATING PLATES WITH UNIQUE JAG GEOMETRY



COMPLIANCE OF THE PARAMETERS OF PLATE HEAT EXCHANGERS WITH TECHNICAL DATA PROVIDED BY HEXONIC



THE POSSIBILITY OF SELECTION BY THE PROPRIETARY CAIRO PROGRAM



GASKETS

PATENTED HYBRID LOCK SYSTEM



New construction of the patented gasket features two locking methods and an optimized unique shape. The hybrid lock system makes the mounting easier, quicker, and more stable throughout the exchanger assembly process. The innovative shape provides superior sealing capacity even in high pressure applications.



LOCK-IN METHOD

Each pin is pressed into the corresponding cut-out in the heating plate. Press-in locks stabilize the gasket on the plate during assembly.

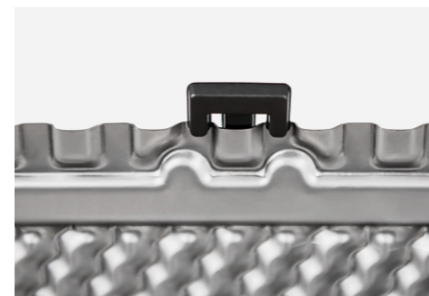

LOCK-ON METHOD

Each T-shape clip catches on the corresponding fragment of the profiled edge of the heating plate fastening the gasket to the vertical side of the plate. It makes the assembly process easier and quicker.

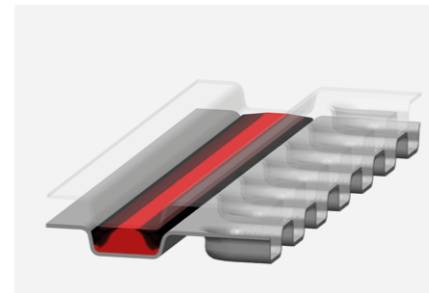

OPTIMIZED UNIQUE SHAPE OF THE GASKET

Provides superior sealing capacity even in high pressure applications.

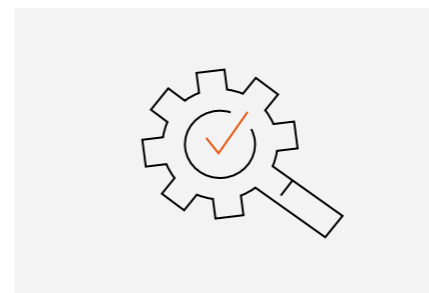

HIGHEST PRODUCTION STANDARDS

Top quality materials and dependability of supply.

CONSTRUCTION

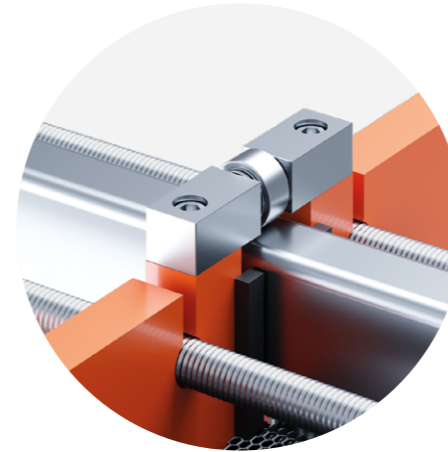

1

METAL ROLLER

In larger models – enables easy sliding of the rear plate thus reducing maintenance time and effort. Rollers are accompanied by Teflon or polyamide slides to stabilize the rear plate.

2

Connection size: DN32 to DN350

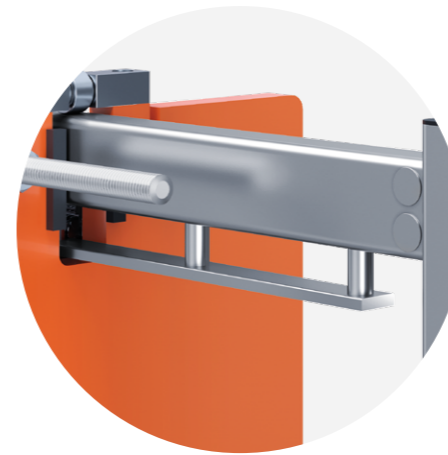

3

SPECIAL PROFILE OF THE CARRYING BAR

Serves to suspend heating plates in larger models. It is part of the five-point alignment system that secures the heating plates in the correct position.

4

Front and rear plate available in various colours.

5

ADDITIONAL FRONT FEET

Stabilize the heat exchanger and help to firmly attach it to the mounting platform.

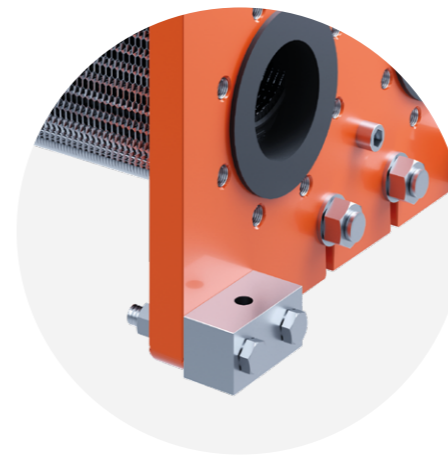

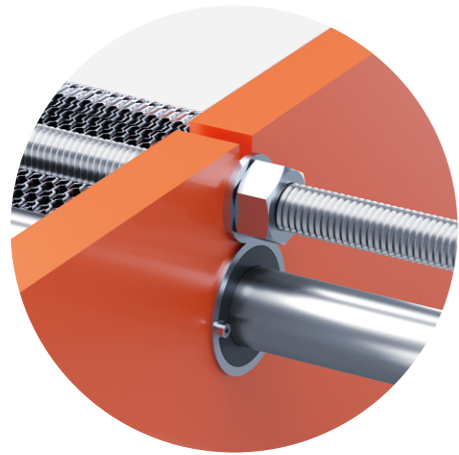

6

SLIDING SLEEVE

In smaller models – makes the service easier and reduces corrosion of the rear plate.

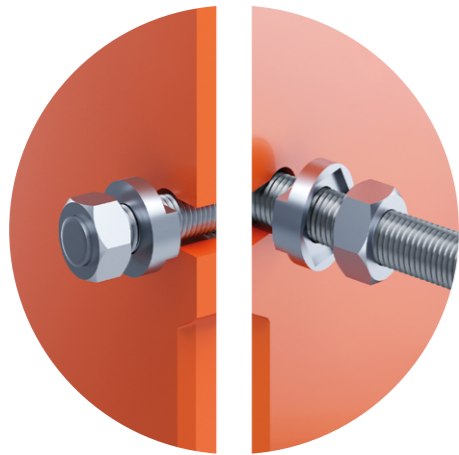

7

LOCK WASHER

Makes it easier and faster to loosen and tighten the bolts.

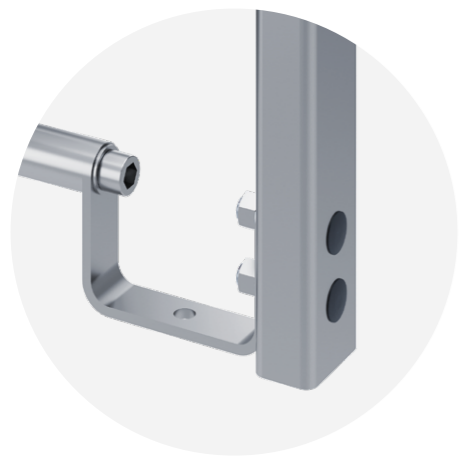

9

U-LEG

Enables easier assembly of the plate pack. It may also be used to fix the heat exchanger to the mounting platform.



10

JAG SafePLATE

The double wall system option helps to prevent the mixing of media and allows for quick detection of leaks in installations where this is crucial.

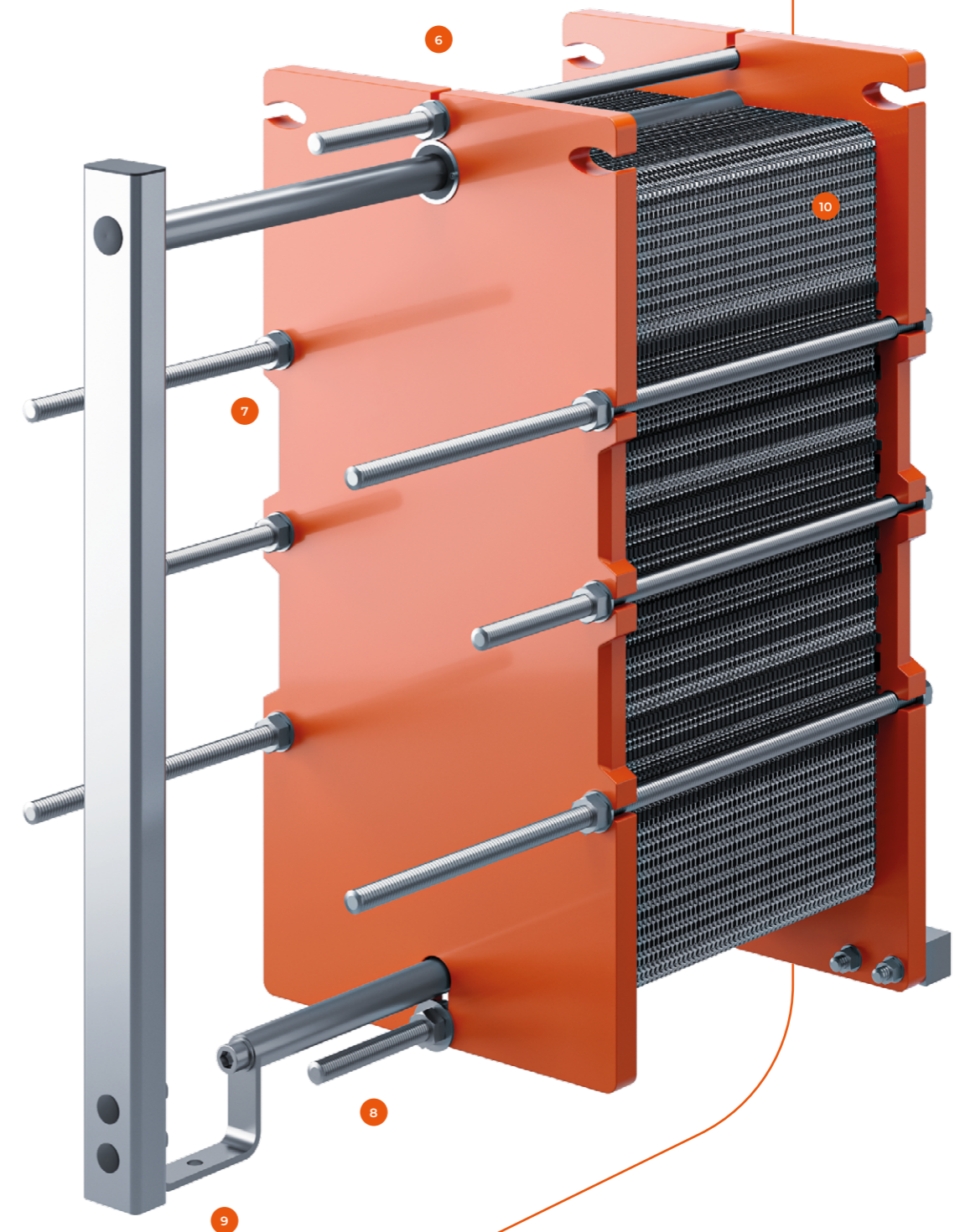

POWER

RUNS IN
THE FAMILY

